



Cable Management System

Metal Raceway Product Range



Cable Strut

Strut is usually formed from metal sheet, folded over into an open channel shape with inwards-curving lips to provide additional stiffness and as a location to mount interconnecting components. Strut usually has holes of some sort in the base, to facilitate interconnection or fastening strut to underlying building structures.

The main advantage of strut channel in construction is that there are many options available for rapidly and easily connecting lengths together and other items to the strut channel, using various specialized strut-specific fasteners and bolts. It can be assembled very rapidly with minimal tools and only moderately trained labor, which reduces costs significantly in many applications. A strut channel installation also can often be modified or added-to relatively easily if needed. The only alternative to strut channel for most applications is custom fabrication using steel bar stock and other commodity components, requiring welding or extensive drilling and bolting, which has none of the above advantages.

In US units, the basic typical strut channel forms a box 1 5/8 inch by 1 5/8 inch. In metric units, this is a 41 mm by 41 mm unit. There are several additional sizes and combined shapes manufactured.

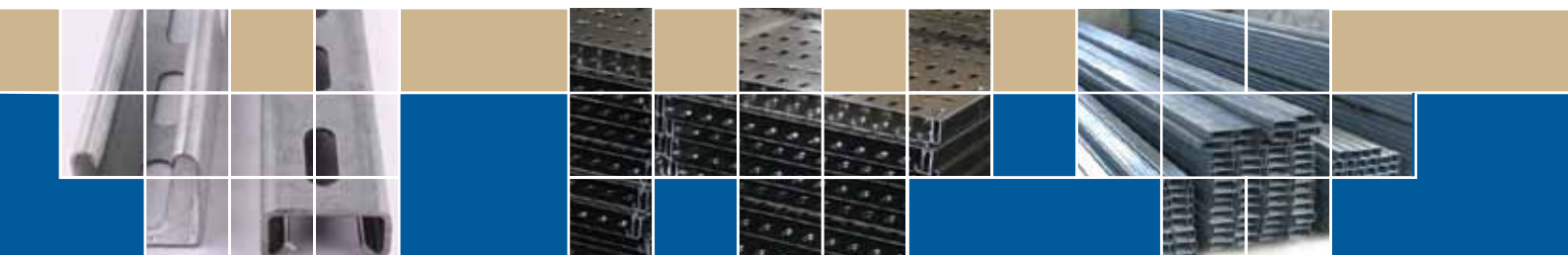

Strut Support:

(Standards, Load Capacity, Support Location and Electrical Grounding)

Kruppsmetal Corporation (Kruppsstrut system) These struts are ideal for supporting all type of Cable ladders, Cable trays, Cable trunking, Pipes and Ductings. It is even called mother of all support in the electrical servicing sector. The strut system is manufactured in these types.

- (1) Deep Channel
- (2) Shallow Channel
- (3) Back to back channel
- (4) Combination of three back to back channel
- (5) Combination of four back to back channel

All the above channels are manufactured in three meters and six meters in length, with 2mm as standard thickness. At any time our standard products are available in ex-stock position at our warehouse.

Material and Finishes:

Pre-galvanized steel to BS EN 10326:2004(PG)

Hot dip galvanized after manufacture to BS EN ISO 1461:1999(HDG)

Stainless steel to 1.4401 / 1.4404 (formerly 316 marine grade) to BS EN 10088-2:2005(SS)

GRP / FRP is as per BS 467 Part 7 Class 1 (GRP)

Material Specification:

Channels: Manufactured from steel complying with BS 1449 or BS2989 (Pre-zinc coated) and to BS EN1461 (Hot dipped galvanized)

Brackets: Manufactured from steel complying with BS970, BS1449 or BS4360 Zinc coated after manufacture to BS729 or BS1706.

Fixings: Bolts, Hexagon nuts, screws and washers manufactured from steel complying with BS3692, BS970, Grade A4 of BS6105 or BS4190 protective coating complying with BS1706 or BS3382.

Note: System Grounding, Equipment Grounding and Methods of Grounding. Please refer to cable ladder section.

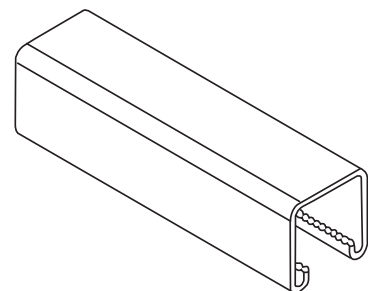

Channel:

Power-Strut channel sections are produced by multiple sets of forming rolls which cold-work strip steel into the channel configuration. This type of roll forming produces a uniform channel section held to the specifications of MFMA-3.

MATERIALS:

Plain and painted green channels are formed from structural quality strip steel which conforms to the requirements of ASTM A-1011 SS Grade 33. Pre-galvanized channel conforms to the requirements of ASTM A-653 Grade 33.

STANDARD LENGTHS:

Stock lengths are 10 and 20 feet. Special lengths are available upon request.

STANDARD FINISHES:

Standard Power-Strut channel is available in plain, painted green, zinc dichromate or pre-galvanized finishes.

ORDERING INFORMATION:

When ordering, add the length or size and finish to the part number. for finish abbreviations and an example.

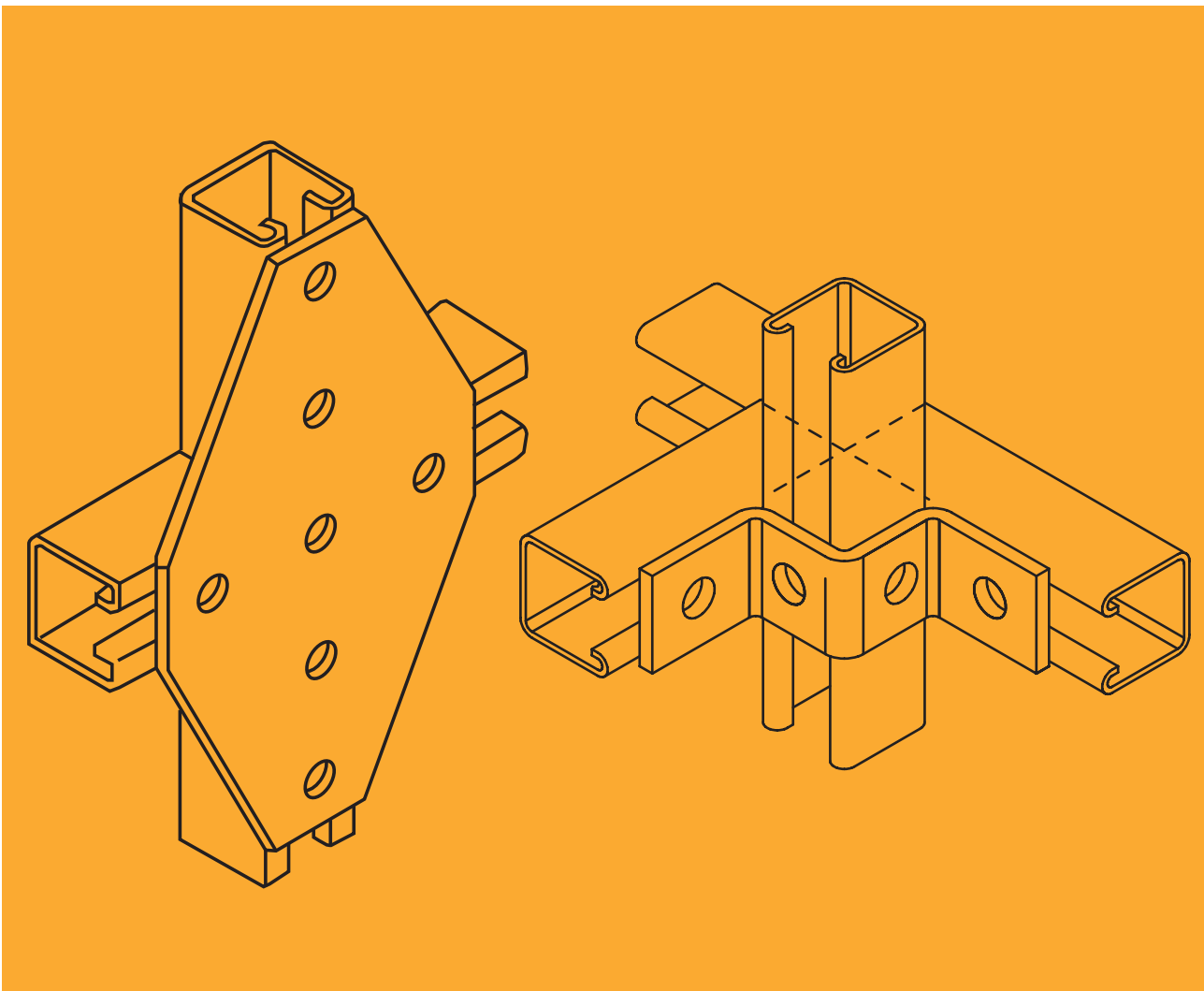

Cantilever Arms

All cantilever arms are mild steel and hot dip galvanized with 14mm diameter holes for M12 hex. head screws as standard.

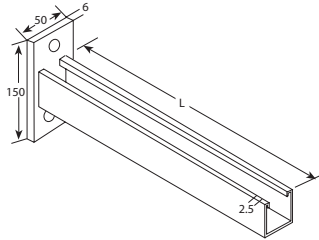

Model No.	W(Kg)	L(mm)
KSCL41150	0.77	150
KSCL41300	1.16	300
KSCL41450	1.56	450
KSCL41600	1.95	600
KSCL41750	2.30	750

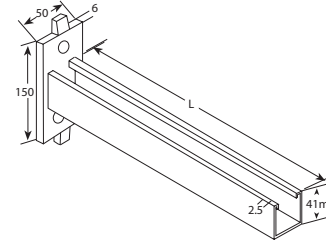

Model No.	W(Kg)	L(mm)
KSCLA41150	0.86	150
KSCLA41300	1.26	300
KSCLA41450	1.66	450
KSCLA41600	2.05	600
KSCLA41750	2.44	750

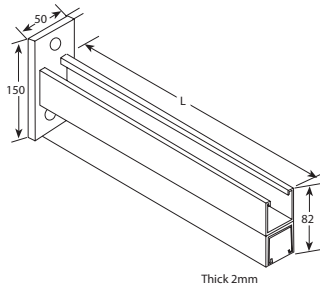

Model No.	W(Kg)	L(mm)
KSCLD41150	1.26	150
KSCLD41300	2.05	300
KSCLD41450	2.85	450
KSCLD41600	3.64	600
KSCLD41750	4.43	750

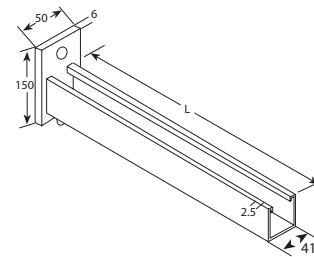

Model No.	W(Kg)	L(mm)
KMCS067150	0.67	150
KMCS106300	1.06	300
KMCS146450	1.46	450
KMCS185600	1.85	600
KMCS230750	2.30	750

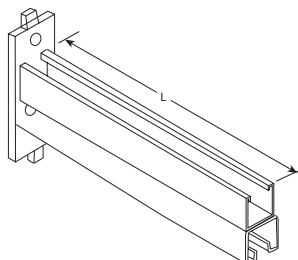

Model No.	W(Kg)	L(mm)
KMCS133150	1.35	150
KMCS215300	2.15	300
KMCS294450	2.94	450
KMCS373600	3.73	600
KMCS452750	4.52	750

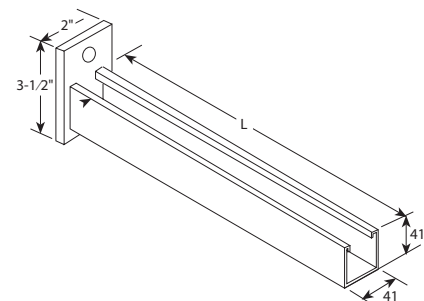
Medium Duty Strut Channel Bracket

Model No.	W(Kg)	L(mm)
KMCL-1	1.35	150
KMCL-2	2.00	300
KMCL-3	2.75	450
KMCL-4	3.60	600
KMCL-5	4.10	750

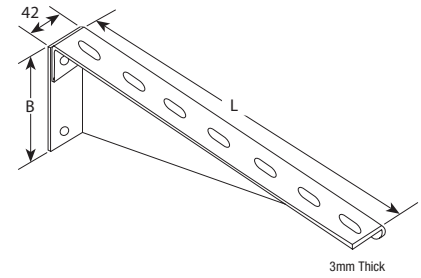
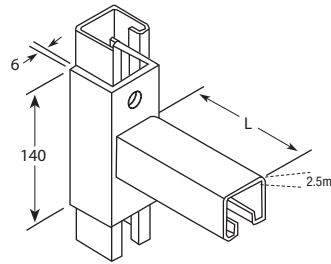
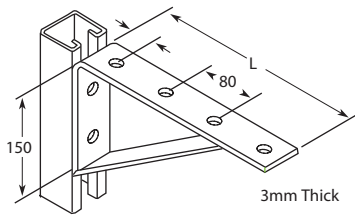

Model No.	Length (mm)
KSCL-15	150
KSCL-30	300
KSCL-45	450
KSCL-60	600
KSCL-75	750

Model No.	Length (mm)
KMCL-15	150
KMCL-30	300
KMCL-45	450
KMCL-60	600
KMCL-75	750

Model No.	Length (mm)
KMLL-15	150
KMLL-30	300
KMLL-45	450
KMLL-60	600
KMLL-75	750

Dimension in Millimeter

Finish

HDG- Hot Dip Galvanized

PG - Pre Galvanized

Al - Aluminum Alloy - SS34 (SS304 Grade), SS36 (SS316 Grade)

EP - Epoxy Coated, PC - PVC Coated, GP-GRP/FRP Products

When ordering please Indicate Material and Finish.

All measurement are in millimeter (mm) unless otherwise specified

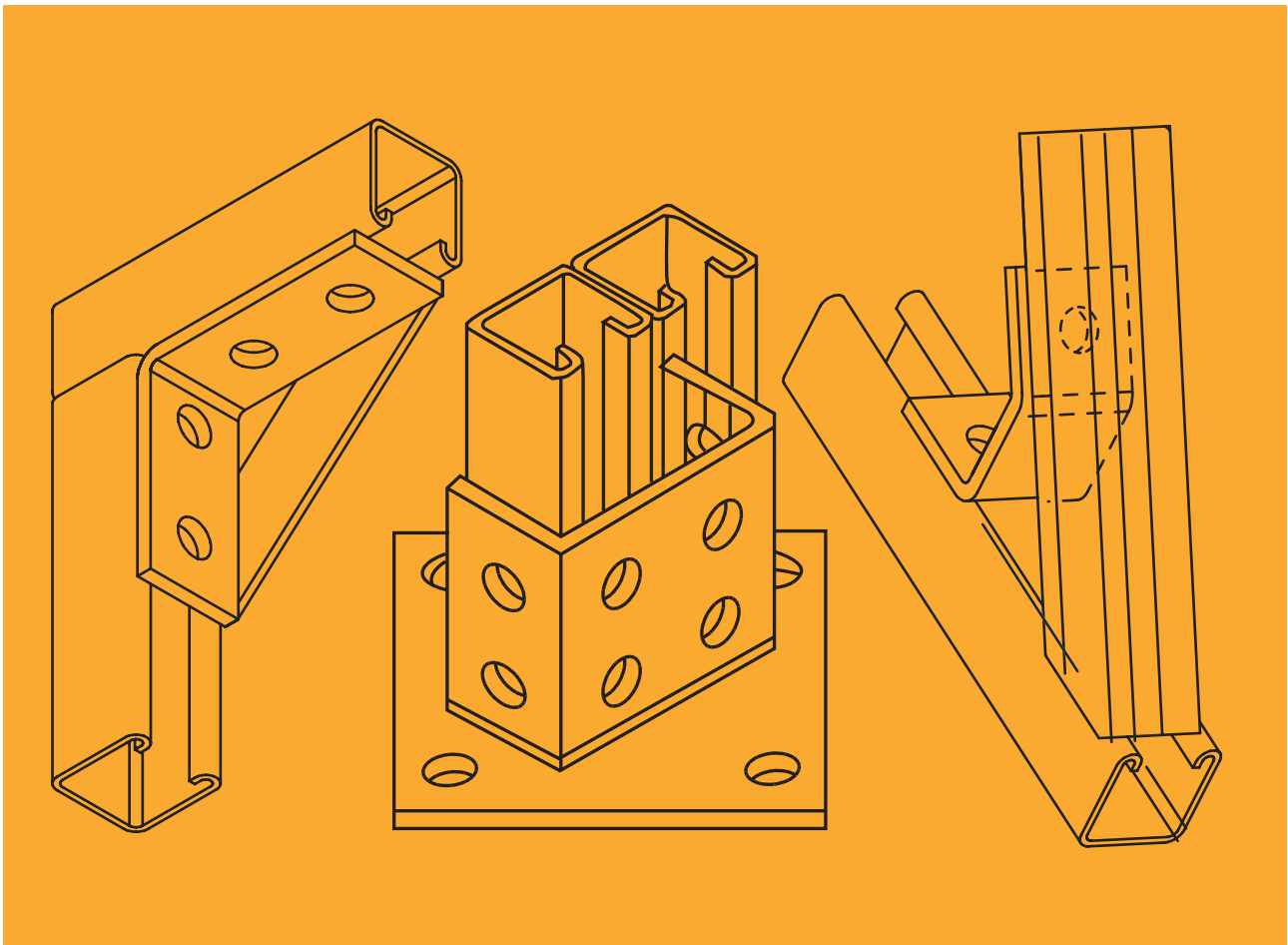

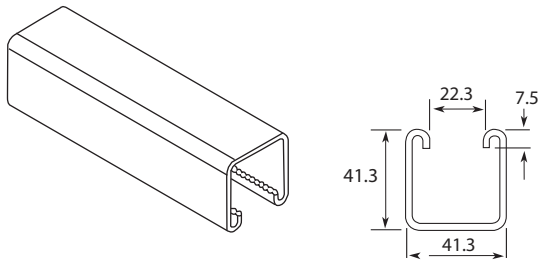
Deep Channel (DC)

Model No.	Size	Thickness	Length	Weight	Finish
KSDC414120	41 x 41	2.0mm	3000mm	7.01Kg	PG / HDG PC / EP / SS
KSDC4141206	41 x 41	2.0mm	6000mm	14.10Kg	
KSDC414125	41 x 41	2.5mm	3000mm	8.01Kg	
KSDC4141256	41 x 41	2.5mm	6000mm	16.30Kg	

PG: Pregalvanized steel as per BS EN 10326 (2004)
 HDG: Hot dipped Galvanized steel as per BS EN ISO 1461(1999)
 EP: Epoxy coated steel in RAL colours
 SS: Stainless Steel to BS EN 10088 - 2(2005)
 PC: PVC Coated

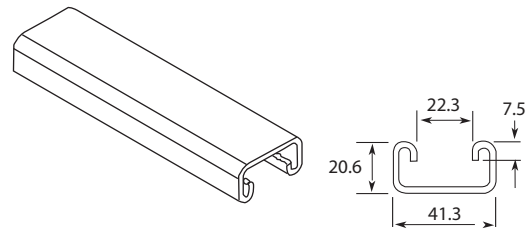
Shallow Channel (SC)

Model No.	Size	Thickness	Length	Weight	Finish
KSSC412120	41 x 21	2.0mm	3000mm	4.85Kg	PG / HDG PC / EP / SS
KSSC4121206	41 x 21	2.0mm	6000mm	9.85Kg	
KSSC412125	41 x 21	2.5mm	3000mm	5.55Kg	
KSSC4121256	41 x 21	2.5mm	6000mm	11.12Kg	

PG: Pregalvanized steel as per BS EN 10326 (2004)
 HDG: Hot dipped Galvanized steel as per BS EN ISO 1461(1999)
 EP: Epoxy coated steel in RAL colours
 SS: Stainless Steel to BS EN 10088 - 2(2005)
 PC: PVC Coated

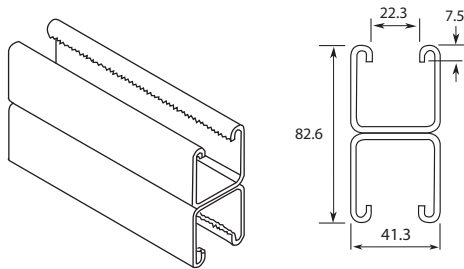
Deep Back to Back Channel (DB)

Model No.	Size	Thickness	Length	Weight	Finish
KSDB414120	41 x 41	2.0mm	3000mm	12.75Kg	PG / HDG PC / EP / SS
KSDB4141206	41 x 41	2.0mm	6000mm	25.65Kg	
KSDB414125	41 x 41	2.5mm	3000mm	16.02Kg	
KSDB414125	41 x 41	2.5mm	6000mm	32.15Kg	

PG: Pregalvanized steel as per BS EN 10326 (2004)
 HDG: Hot dipped Galvanized steel as per BS EN ISO 1461(1999)
 EP: Epoxy coated steel in RAL colours
 SS: Stainless Steel to BS EN 10088 - 2(2005)
 PC: PVC Coated

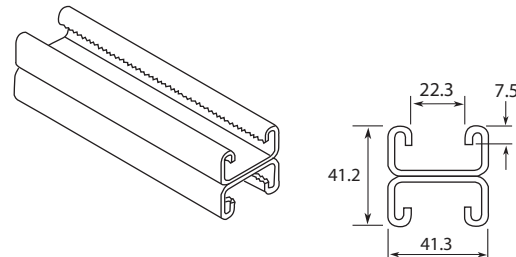
Shallow Back to Back Channel (SB)

Model No.	Size	Thickness	Length	Weight	Finish
KSSB412120	41 x 21	2.0mm	3000mm	9.25Kg	PG / HDG PC / EP / SS
KSSB4121206	41 x 21	2.0mm	6000mm	18.62Kg	
KSSB412125	41 x 21	2.5mm	3000mm	11.1Kg	
KSSB4121256	41 x 21	2.5mm	6000mm	22.25Kg	

PG: Pregalvanized steel as per BS EN 10326 (2004)
 HDG: Hot dipped Galvanized steel as per BS EN ISO 1461(1999)
 EP: Epoxy coated steel in RAL colours
 SS: Stainless Steel to BS EN 10088 - 2(2005)
 PC: PVC Coated

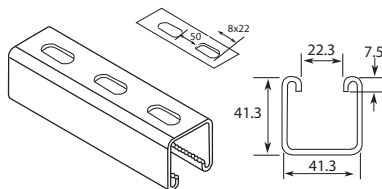
Deep Slotted Channel (DSC)

Model No.	Size	Thickness	Length	Weight	Finish
KSDSC414120	41 x 41	2.0mm	3000mm	6.59Kg	PG / HDG PC / EP / SS
KSDSC4141206	41 x 41	2.0mm	6000mm	13.25Kg	
KSDSC414125	41 x 41	2.5mm	3000mm	7.59Kg	
KSDSC414125	41 x 41	2.5mm	6000mm	15.25Kg	

PG: Pregalvanized steel as per BS EN 10326 (2004)
 HDG: Hot dipped Galvanized steel as per BS EN ISO 1461(1999)
 EP: Epoxy coated steel in RAL colours
 SS: Stainless Steel to BS EN 10088 - 2(2005)
 PC: PVC Coated

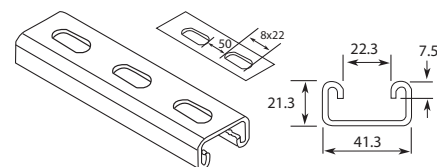

Shallow Slotted Channel (SSC)

Model No.	Size	Thickness	Length	Weight	Finish
KSSSC412120	41 x 21	2.0mm	3000mm	4.43Kg	PG / HDG PC / EP / SS
KSSSC4121206	41 x 21	2.0mm	6000mm	8.95Kg	
KSSSC412125	41 x 21	2.5mm	3000mm	5.13Kg	
KSSSC4121256	41 x 21	2.5mm	6000mm	10.35Kg	

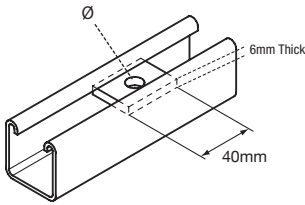
PG: Pregalvanized steel as per BS EN 10326 (2004)
 HDG: Hot dipped Galvanized steel as per BS EN ISO 1461(1999)
 EP: Epoxy coated steel in RAL colours
 SS: Stainless Steel to BS EN 10088 - 2(2005)
 PC: PVC Coated

Internal washer

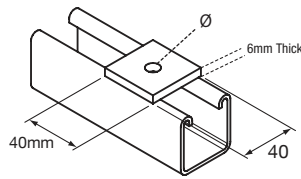
Model	Hole Size
KSC-6	6m
KSI-8	8m
KSI-10	10m
KSI-12	12m

Square washer

Model	Hole Size
KSW-6	6m
KSW-8	8m
KSW-10	10m
KSW-12	12m

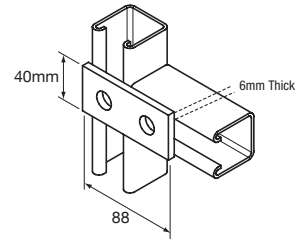
Two hole plate

Model	Hole Size
KS2P-6	6m
KS2P-8	8m
KS2P-10	10m
KS2P-12	12m

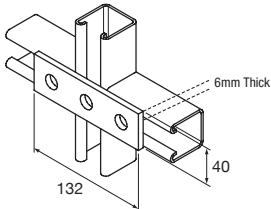
Three hole plate

Model	Hole Size
KSP3-6	6m
KSP3-8	8m
KSP3-10	10m
KSP3-12	12m

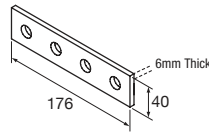
Four hole plate

Model	Hole Size
KSP4-6	6m
KSP4-8	8m
KSP4-10	10m
KSP4-12	12m

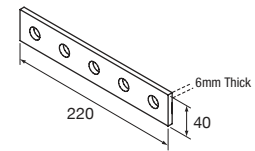
Five hole plate

Model	Hole Size
KSP5-6	6m
KSP5-8	8m
KSP5-10	10m
KSP5-12	12m

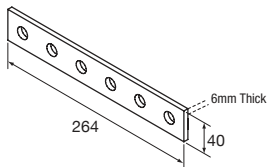
Six hole plate

Model	Hole Size
KSP6-6	6m
KSP6-8	8m
KSP6-10	10m
KSP6-12	12m

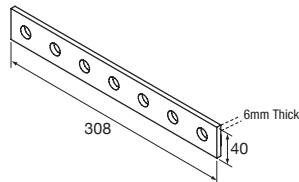
Seven hole plate

Model	Hole Size
KSP7-6	6m
KSP7-8	8m
KSP7-10	10m
KSP7-12	12m

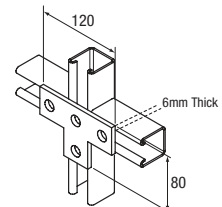
"T" bracket

Model	Hole Size
KSTP-6	6m
KSTP-8	8m
KSTP-10	10m
KSTP-12	12m

Dimension in Millimeter

Finish

HDG-Hot Dip Galvanized

PG - Pre Galvanized

Al - Aluminum Alloy - SS34 (SS304 Grade), SS36 (SS316 Grade)

EP - Epoxy Coated, PC - PVC Coated, GP-GRP/FRP Products

When ordering please Indicate Material and Finish.

All measurement are in millimeter (mm) unless otherwise specified

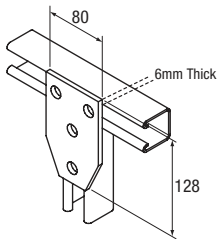
Four Hole Plate

Model	Hole Size
KSFP-6	6m
KSFP-8	8m
KSFP-10	10m
KSFP-12	12m

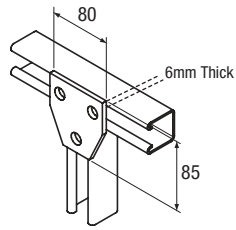
Three hole plate

Model	Hole Size
KSF3-6	6m
KSF3-8	8m
KSF3-10	10m
KSF3-12	12m

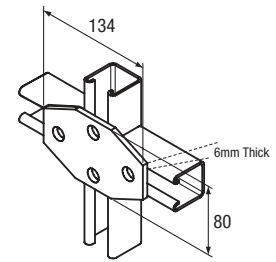
Four hole plate

Model	Hole Size
KSF4-6	6m
KSF4-8	8m
KSF4-10	10m
KSF4-12	12m

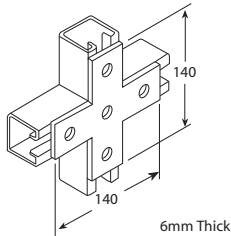
Cross Plate

Model	Hole Size
KSP4-8	8m
KSP4-10	10m
KSP4-12	12m

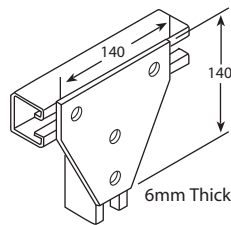
4 Hole Plate

Model	Hole Size
KSP6-8	8m
KSP4-10	10m
KSP4-12	12m

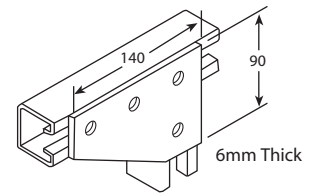
4 Hole Plate

Model	Hole Size
KPW4-8	8m
KPW4-10	10m
KPW4-12	12m

Dimension in Millimeter

Finish

HDG-Hot Dip Galvanized

PG - Pre Galvanized

Al - Aluminum Alloy - SS34 (SS304 Grade), SS36 (SS316 Grade)

EP - Epoxy Coated, PC - PVC Coated, GP-GRP/FRP Products

When ordering please Indicate Material and Finish.

All measurement are in millimeter (mm) unless otherwise specified

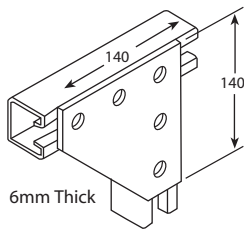
5 Hole Plate

Model	Hole Size
KPW5-8	8m
KPW5-10	10m
KPW5-12	12m

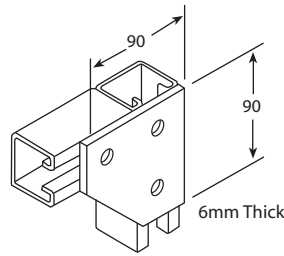
3 Hole Plate

Model	Hole Size
KPW3-8	8m
KPW3-10	10m
KPW3-12	12m

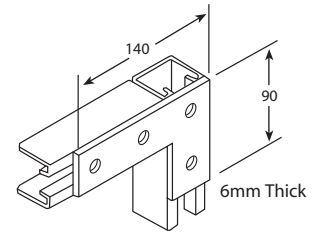
4 Hole Plate

Model	Hole Size
KPL4-8	8m
KPL4-10	10m
KPL4-12	12m

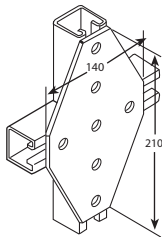
7 Hole Plate

Model	Hole Size
KPW7-8	8m
KPW7-10	10m
KPW7-12	12m

Dimension in Millimeter

Finish

HDG- Hot Dip Galvanized

PG - Pre Galvanized

Al - Aluminum Alloy - SS34 (SS304 Grade), SS36 (SS316 Grade)

EP - Epoxy Coated, PC - PVC Coated, GP-GRP/FRP Products

When ordering please Indicate Material and Finish.

All measurement are in millimeter (mm) unless otherwise specified

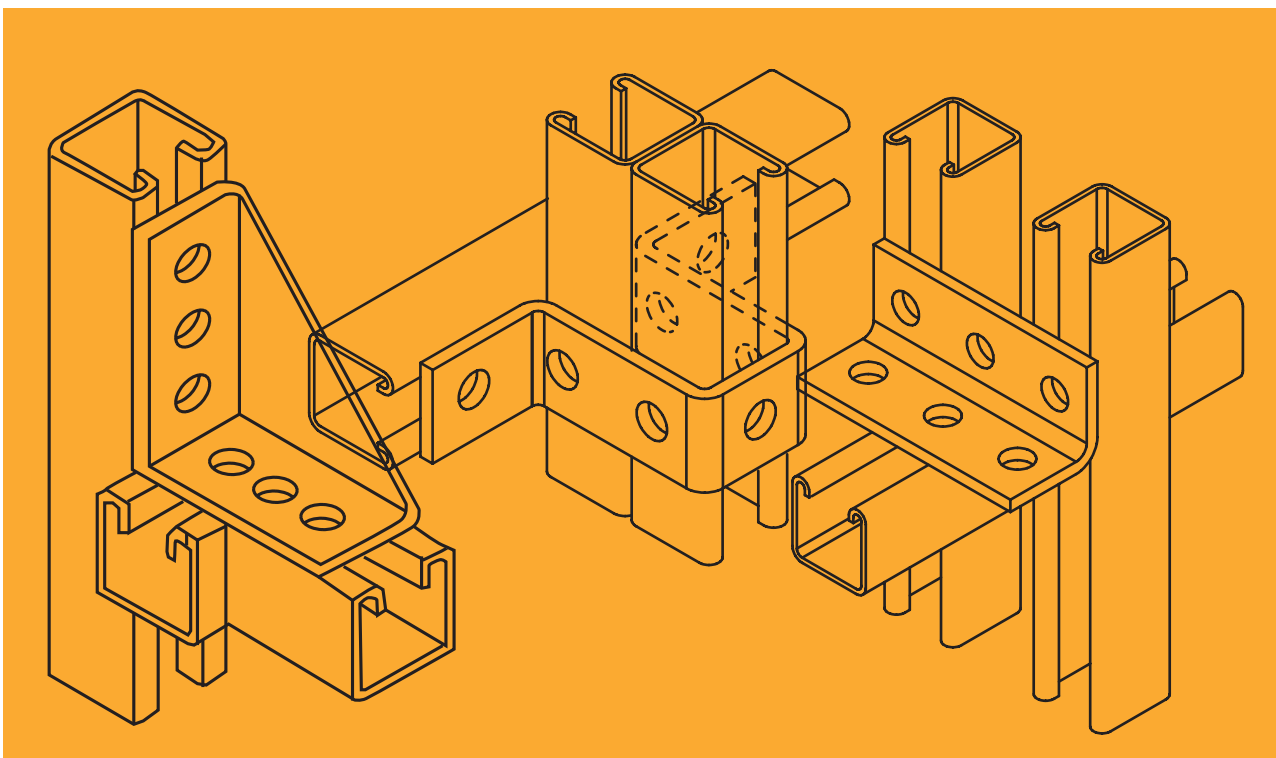

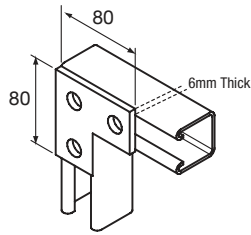

'L' bracket

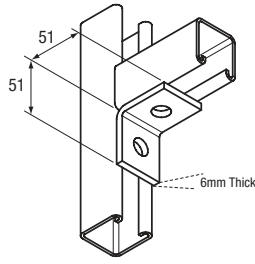
Model	Hole Size
KSLP-6	8m
KSLP-8	10m
KSLP-10	12m
KSLP-12	12m

Right angle 2 hole bracket

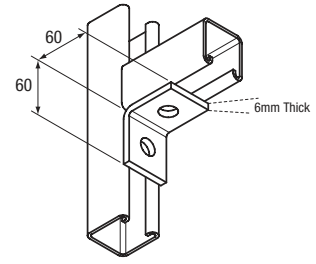
Model	Hole Size
KSR2-6	6m
KSR2-8	8m
KSR2-10	10m
KSR2-12	12m

Right angle 2 hole bracket

Model	Hole Size
KSR21-6	6m
KSR21-8	8m
KSR21-10	10m
KSR21-12	12m

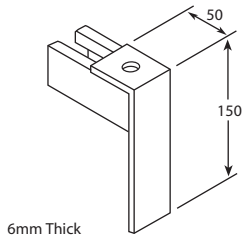
L bracket

Model	Hole Size
KAPI-6	8m
KAPI-8	10m
KAPI-10	12m
KAPI-12	12m

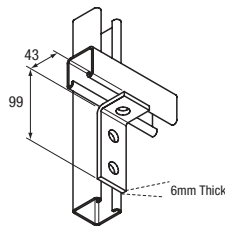
Right angle 3 hole bracket

Model	Hole Size
KSR3-6	8m
KSR3-8	10m
KSR3-10	12m
KSR3-12	12m

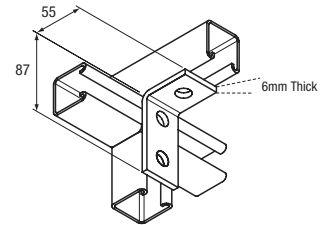
Right angle 3 hole bracket

Model	Hole Size
KSR31-6	8m
KSR31-8	10m
KSR31-10	12m
KSR31-12	12m

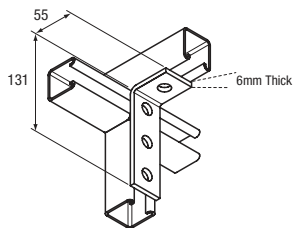
Right angle 5 hole bracket

Model	Hole Size
KSR4-6	8m
KSR4-8	10m
KSR4-10	12m
KSR4-12	12m

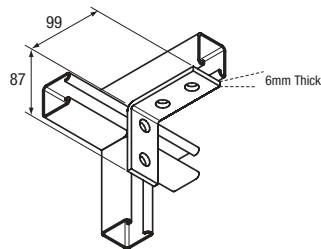
Right angle 4 hole bracket

Model	Hole Size
KSR41-6	8m
KSR41-8	10m
KSR41-10	12m
KSR41-12	12m

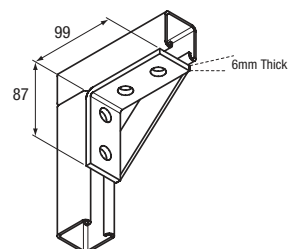
Right angle 4 hole bracket

Model	Hole Size
KSRT-6	8m
KSRT-8	10m
KSRT-10	12m
KSRT-12	12m

Dimension in Millimeter

Finish

HDG - Hot Dip Galvanized

PG - Pre Galvanized

Al - Aluminum Alloy - SS34 (SS304 Grade), SS36 (SS316 Grade)

EP - Epoxy Coated, PC - PVC Coated, GP - GRP/FRP Products

When ordering please Indicate Material and Finish.

All measurement are in millimeter (mm) unless otherwise specified

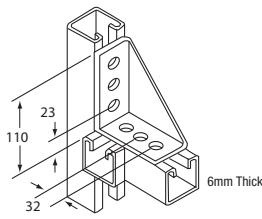

Model	Hole Size
KSF6-6	8m
KSF6-8	10m
KSF6-10	12m
KSF6-12	12m

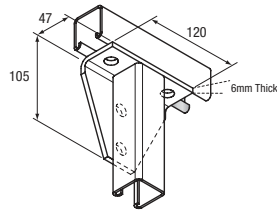
Right angle bracket

Model	Hole Size
KRTA-6	8m
KRTA-8	10m
KRTA-10	12m
KRTA-12	12m

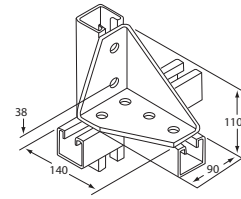
Support 6 hole angle bracket

Model	Hole Size
KA6F	8m
KA6F8	10m
KA6F10	12m
KA6F12	12m

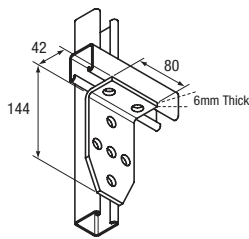
Right angle 7 hole bracket

Model	Hole Size
KRT7-6	6m
KRT7-8	8m
KRT7-10	10m
KRT7-12	12m

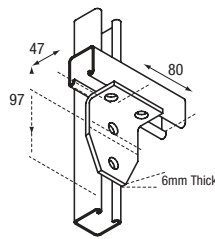
Right angle 4 hole bracket

Model	Hole Size
KRT4-6	6m
KRT4-8	8m
KRT4-10	10m
KRT4-12	12m

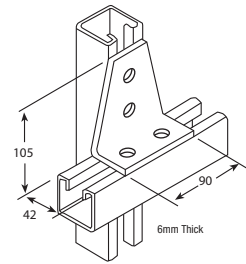
Right angle 4 hole bracket

Model	Hole Size
KP4W6	6m
KP4W6	8m
KP4W6	10m
KP4W6	12m

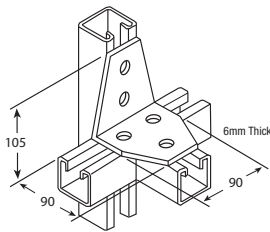
Angle Bracket 5 hole

Model	Hole Size
KP5W-6	6m
KP5W-8	8m
KP5W-10	10m
KP5W-12	12m

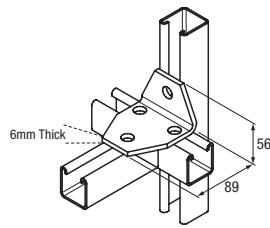
Right angle 4 hole bracket

Model	Hole Size
KRA4-6	6m
KRA4-8	8m
KRA4-10	10m
KRA4-12	12m

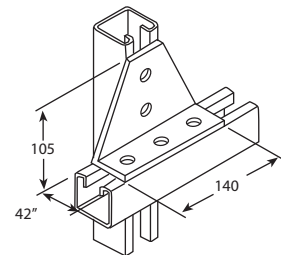
Angle Bracket 5 hole

Model	Hole Size
KP5W-6	6m
KP5W-8	8m
KP5W-10	10m
KP5W-12	12m

Dimension in Millimeter

Finish

HDG-Hot Dip Galvanized

PG - Pre Galvanized

Al - Aluminum Alloy - SS34 (SS304 Grade), SS36 (SS316 Grade)

EP - Epoxy Coated, PC - PVC Coated, GP-GRP/FRP Products

When ordering please Indicate Material and Finish.

All mesasurement are in millimeter (mm) unless otherwise specified

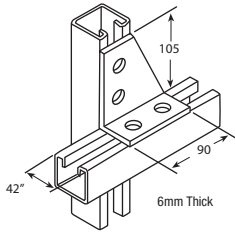
Angle Bracket 5 hole

Model	Hole Size
KP4U-6	6m
KP4U-8	8m
KP4U-10	10m
KP4U-12	12m

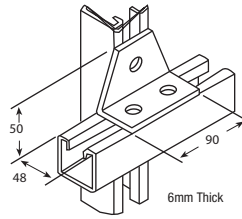
Right angle 4 hole bracket

Model	Hole Size
KP3U-6	6m
KP3U-8	8m
KP3U-10	10m
KP3U-12	12m

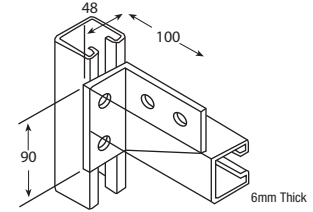
Angle Bracket 5 hole

Model	Hole Size
KPL4-6	6m
KPL4-8	8m
KPL4-10	10m
KPL4-12	12m

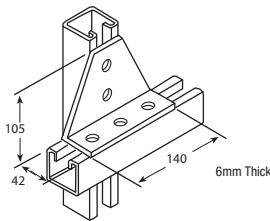
Angle Bracket 5 hole

Model	Hole Size
KP5U-6	6m
KP5U-8	8m
KP5U-10	10m
KP5U-12	12m

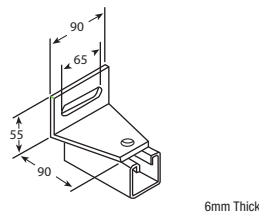
Angle bracket 5 hole

Model	Hole Size
KPU3-6	6m
KPU3-8	8m
KPU3-10	10m
KPU3-12	12m

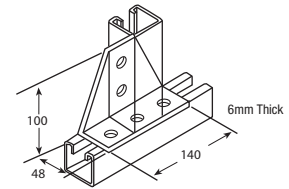
Angle Bracket 5 hole

Model	Hole Size
KPU5-6	6m
KPU5-8	8m
KPU5-10	10m
KPU5-12	12m

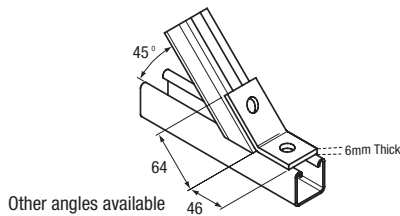
Obtuse Angle Bracket

Model	Hole Size
KOAB-6	64x46x6
KOAB-8	64x46x8
KOAB-10	64x46x10
KOAB-12	64x46x12

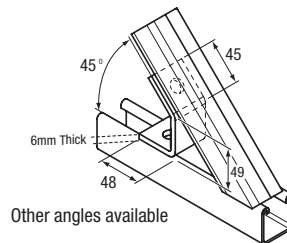
Acute Angle Bracket

Model	Hole Size
KAAB-6	45x48x49x6
KAAB-8	45x48x49x8
KAAB-10	45x48x49x10
KAAB-12	45x48x49x12

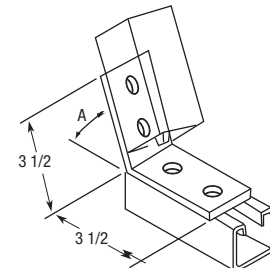
Obtuse Angle Bracket 4 Hole

Model	Hole Size
KAF4-6	45x48x49x6
KAF4-8	45x48x49x8
KAF4-10	45x48x49x10
KAF4-12	45x48x49x12

Dimension in Millimeter

Finish

HDG-Hot Dip Galvanized

PG - Pre Galvanized

Al - Aluminum Alloy - SS34 (SS304 Grade), SS36 (SS316 Grade)

EP - Epoxy Coated, PC - PVC Coated, GP-GRP/FRP Products

When ordering please Indicate Material and Finish.

All measurements are in millimeter (mm) unless otherwise specified

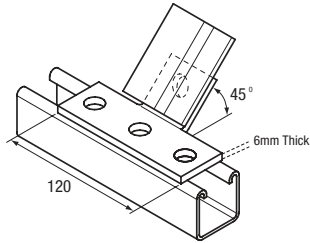
45° Angle Bracket

Model	Hole Size
K4HB-6	120x42x6
K4HB-8	120x42x8
K4HB-10	120x42x10
K4HB-12	120x42x12

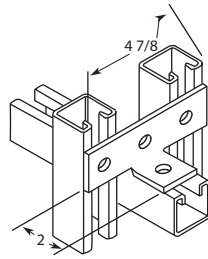
T Angle Bracket

Model	Hole Size
KPT4-6	120x42x6
KPT4-8	120x42x8
KPT4-10	120x42x10
KPT4-12	120x42x12

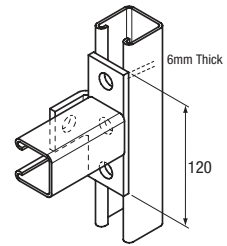
Channel support bracket

Model	Hole Size
KCSB-8	120x42x8
KCSB-8	120x42x8
KCSB-10	120x42x10
KCSB-12	120x42x12

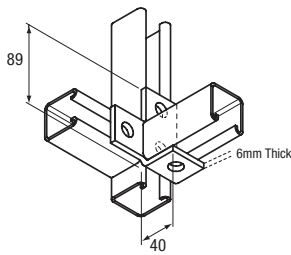
Channel Support Bracket

Model	Hole Size
KLSB-6	189x42x6
KLSB-8	189x42x6
KLSB-10	189x42x6
KLSB-12	189x42x6

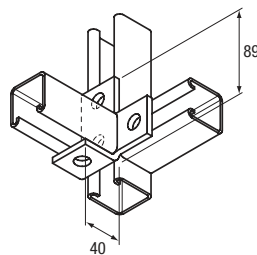
Channel Support Bracket

Model	Hole Size
KRSB-6	89x42x6
KRSB-8	89x42x8
KRSB-10	89x42x10
KRSB-12	89x42x12

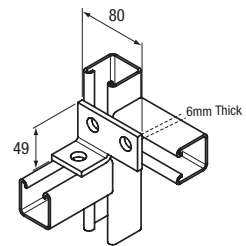
Channel Support Bracket

Model	Hole Size
KLCB-6	80x42x6
KLCB-8	80x42x10
KLCB-10	80x42x10
KLCB-12	80x42x12

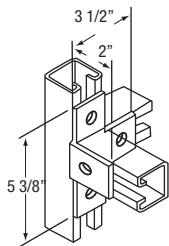
Cross Angle Bracket 4 Hole

Model	Hole Size
KA4T-6	189x42x6
KA4T-8	189x42x6
KA4T-10	189x42x6
KA4T-12	189x42x6

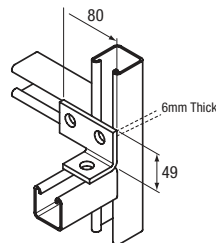
Channel Support Bracket (Right Hand)

Model	Hole Size
KRCB-6	80x42x6
KRCB-8	80x42x10
KRCB-10	80x42x10
KRCB-12	80x42x12

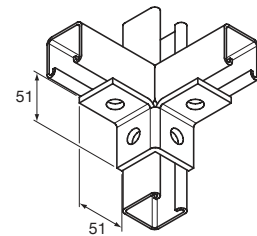
Three Way Corner

Model	Hole Size
K3CB-6	51x51x6
K3CB-8	51x51x8
K3CB-10	51x51x10
K3CB-12	51x51x12

Dimension in Millimeter

Finish

HDG-Hot Dip Galvanized

PG - Pre Galvanized

Al - Aluminum Alloy - SS34 (SS304 Grade), SS36 (SS316 Grade)

EP - Epoxy Coated, PC - PVC Coated, GP-GRP/FRP Products

When ordering please Indicate Material and Finish.

All measurement are in millimeter (mm) unless otherwise specified

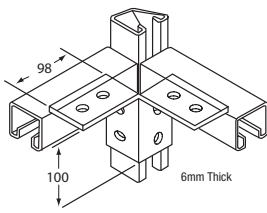
Channel Support Bracket

Model	Hole Size
KAF8-6	51x51x6
KAF8-8	51x51x8
KAF8-10	51x51x10
KAF8-12	51x51x12

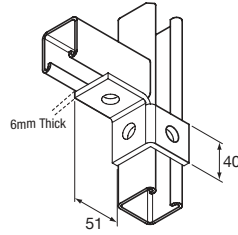
Channel Support Bracket (Left Hand)

Model	Hole Size
KLCS-6	51x40x6
KLCS-8	51x40x8
KLCS-10	51x40x10
KLCS-12	51x40x12

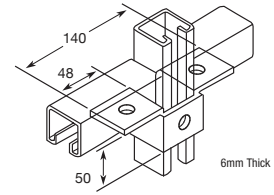
Channel Support Bracket

Model	Hole Size
KAF3-6	51x40x6
KAF3-8	51x40x8
KAF3-10	51x40x10
KAF3-12	51x40x12

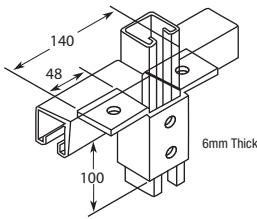
Channel Support Bracket

Model	Hole Size
KAF4-6	51x51x6
KAF4-8	51x51x8
KAF4-10	51x51x10
KAF4-12	51x51x12

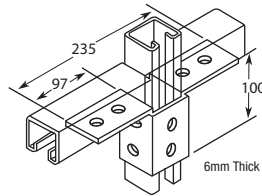
Channel Support Bracket

Model	Hole Size
KAF10-6	51x51x6
KAF10-8	51x51x8
KAF10-10	51x51x10
KAF10-12	51x51x12

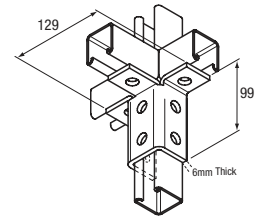
Three leg wing fitting

Model	Hole Size
KSWP-6	129x99x6
KSWP-8	129x99x8
KSWP-10	129x99x10
KSWP-12	129x99x12

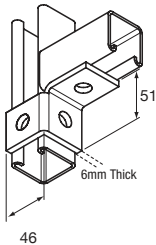
Channel Support Bracket

Model	Hole Size
KS3W-6	51x51x6
KS3W-8	51x51x8
KS3W-10	51x51x10
KS3W-12	51x51x12

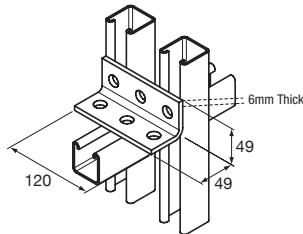
Angle Support Bracket

Model	Hole Size
KSAB-6	51x51x6
KSAB-8	51x51x8
KSAB-10	51x51x10
KSAB-12	51x51x12

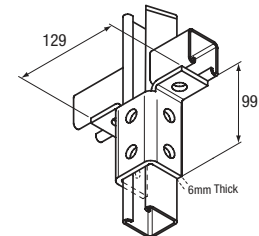
Two leg wing fitting

Model	Hole Size
K2WB-6	129x99x6
K2WB-8	129x99x6
K2WB-10	129x99x6
K2WB-12	129x99x6

Dimension in Millimeter

Finish

HDG-Hot Dip Galvanized

PG - Pre Galvanized

Al - Aluminum Alloy - SS34 (SS304 Grade), SS36 (SS316 Grade)

EP - Epoxy Coated, PC - PVC Coated, GP-GRP/FRP Products

When ordering please Indicate Material and Finish.

All measurement are in millimeter (mm) unless otherwise specified

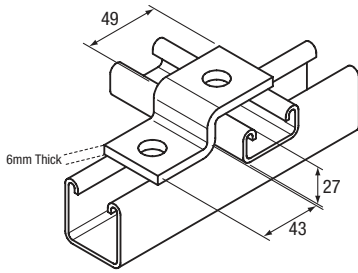
'Z' shaped shallow bracket

Model	Hole Size
KSZ2-6	6m
KSZ2-8	8m
KSZ2-10	10m
KSZ2-12	12m

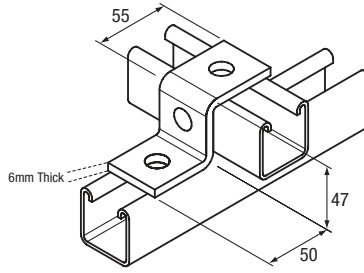
'Z' shaped deep bracket

Model	Hole Size
KSZ3-6	6m
KSZ3-8	8m
KSZ3-10	10m
KSZ3-12	12m

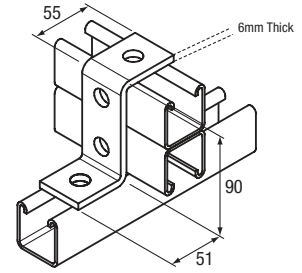
'Z' shaped multiple bracket

Model	Hole Size
KSZ4-6	6m
KSZ4-8	8m
KSZ4-10	10m
KSZ4-12	12m

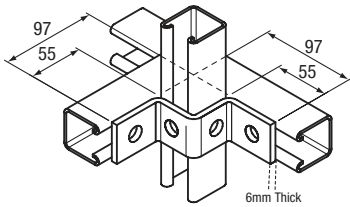
'W' shaped bracket

Model	Hole Size
KS4W-6	6m
KS4W-8	8m
KS4W-10	10m
KS4W-12	12m

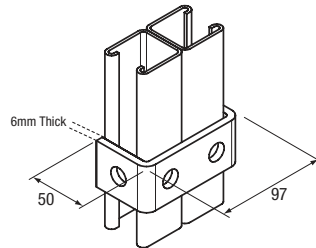
Back to back bracket

Model	Hole Size
KSBB-6	6m
KSBB-8	8m
KSBB-10	10m
KSBB-12	12m

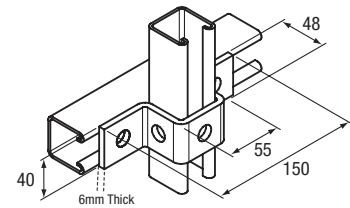
'U' shaped deep bracket

Model	Hole Size
KSUB-6	6m
KSUB-8	8m
KSUB-10	10m
KSUB-12	12m

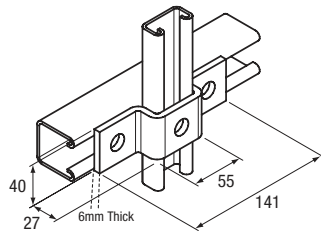
'U' shaped shallow bracket

Model	Hole Size
KUSB-6	6m
KUSB-8	8m
KUSB-10	10m
KUSB-12	12m

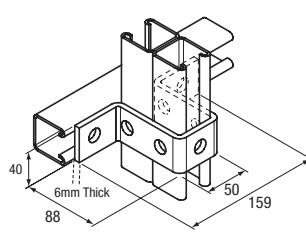
Multiple channel bracket

Model	Hole Size
KUMB-6	6m
KUMB-8	8m
KUMB-10	10m
KUMB-12	12m

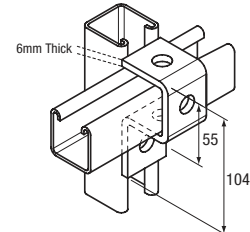
'U' type deep bracket

Model	Hole Size
KSU3-6	6m
KSU3-8	8m
KSU3-10	10m
KSU3-12	12m

Dimension in Millimeter

Finish

HDG-Hot Dip Galvanized

PG - Pre Galvanized

Al - Aluminum Alloy - SS34 (SS304 Grade), SS36 (SS316 Grade)

EP - Epoxy Coated, PC - PVC Coated, GP-GRP/FRP Products

When ordering please Indicate Material and Finish.

All measurement are in millimeter (mm) unless otherwise specified

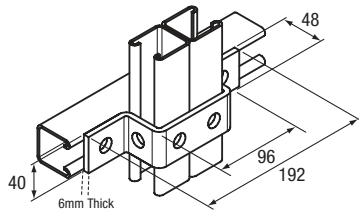

Double channel bracket

Model	Hole Size
KSDB-6	6m
KSDB-8	8m
KSDB-10	10m
KSDB-12	12m

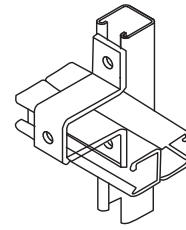

Single Channel Top Hat

Model	Hole Size
K3DB-6	6m
K3DB-8	8m
K3DB-10	10m
K3DB-12	12m

Dimension in Millimeter

Finish

HDG-Hot Dip Galvanized

PG - Pre Galvanized

Al - Aluminum Alloy - SS34 (SS304 Grade), SS36 (SS316 Grade)

EP - Epoxy Coated, PC - PVC Coated, GP-GRP/FRP Products

When ordering please Indicate Material and Finish.

All measurement are in millimeter (mm) unless otherwise specified

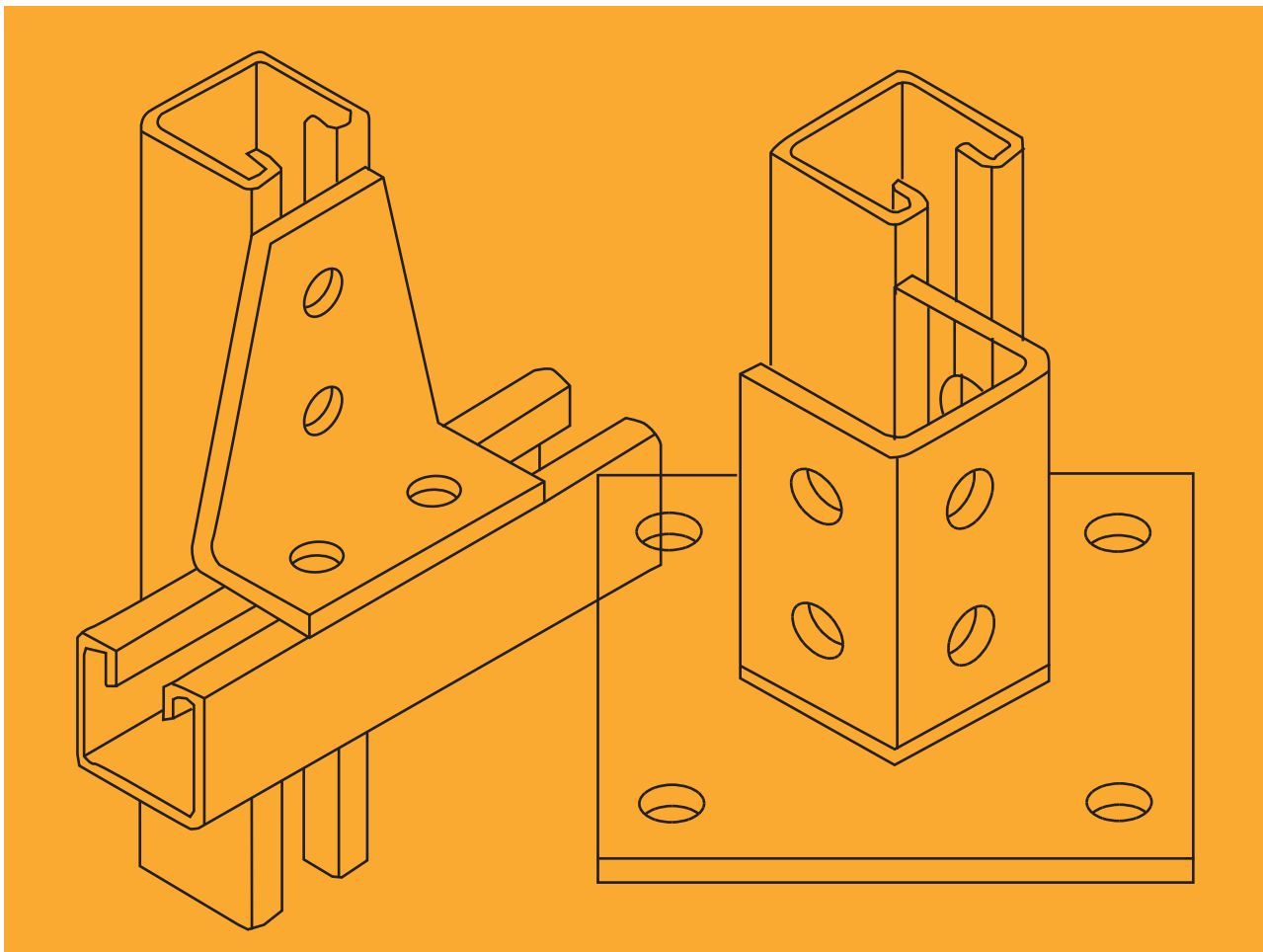

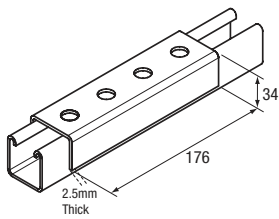
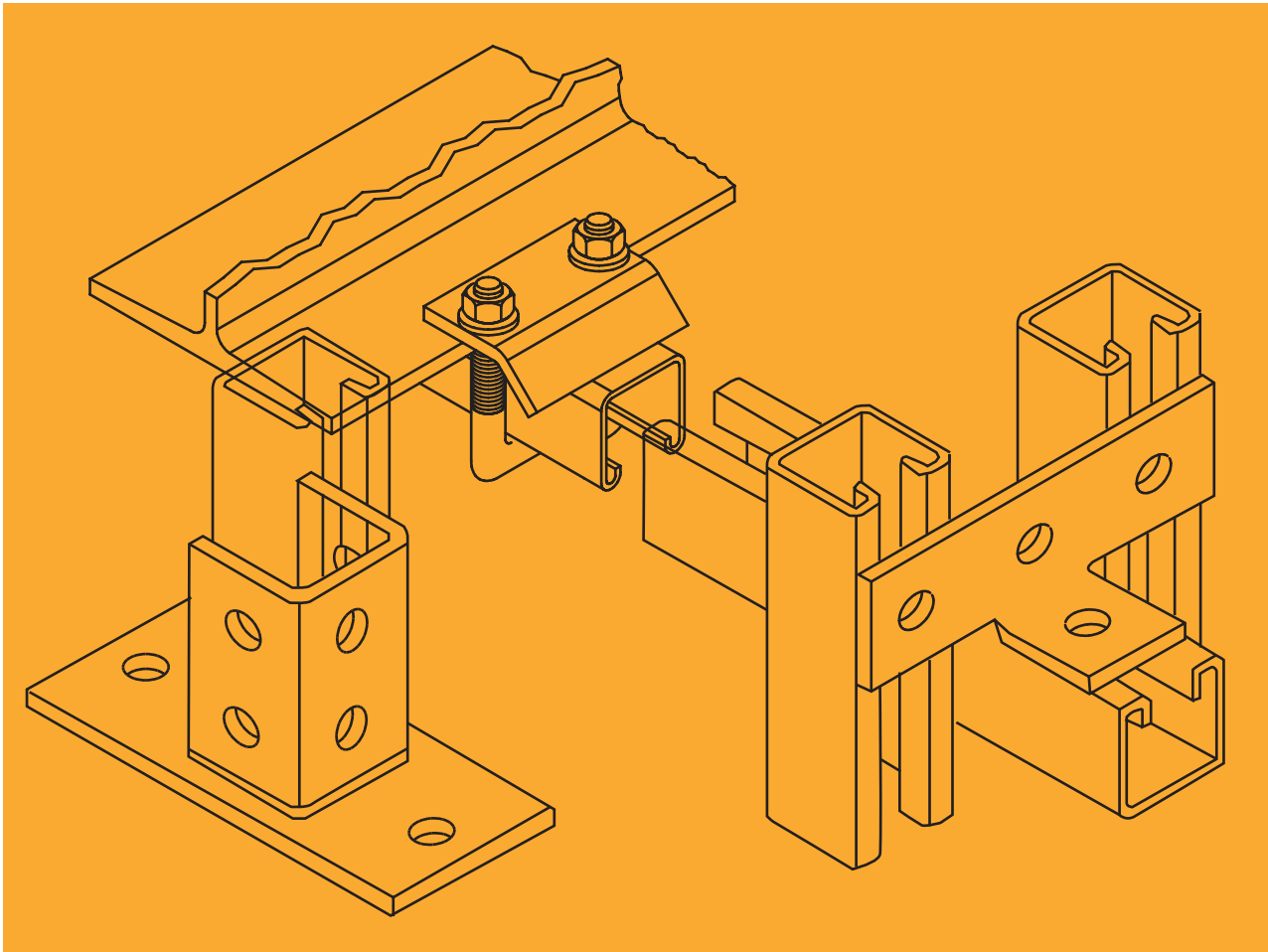

Deep external connector

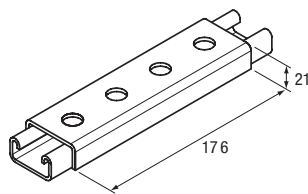
Model	Hole Size
KCDC-6	34x176x6
KCDC-8	34x176x8
KCDC-10	34x176x10
KCDC-12	34x176x12

Shallow external connector

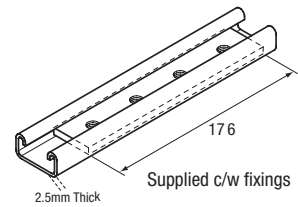
Model	Hole Size
KCSC-6	21x176x6
KCSC-8	21x176x8
KCSC-10	21x176x10
KCSC-12	21x176x12

Shallow internal connector

Model	Hole Size
KSIC-6	21x176x6
KSIC-8	21x176x8
KSIC-10	21x176x10
KSIC-12	21x176x12

Dimension in Millimeter

Finish
 HDG- Hot Dip Galvanized
 PG - Pre Galvanized
 Al - Aluminum Alloy - SS34 (SS304 Grade), SS36 (SS316 Grade)
 EP - Epoxy Coated, PC - PVC Coated, GP-GRP/FRP Products
 When ordering please Indicate Material and Finish.
 All measurement are in millimeter (mm) unless otherwise specified

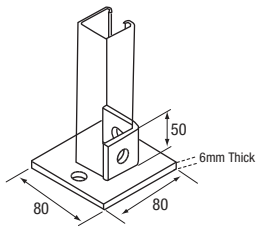
Base Plate

Model	Hole Size
KSP3-6	80x80x6
KSP3-8	80x80x8
KSP3-10	80x80x10
KSP3-12	80x80x12

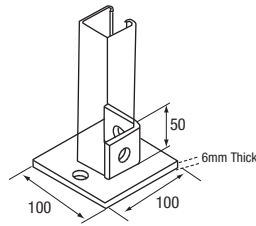
Base Plate

Model	Hole Size
KBP3-6	80x80x6
KBP3-8	80x80x8
KBP3-10	80x80x10
KBP3-12	80x80x12

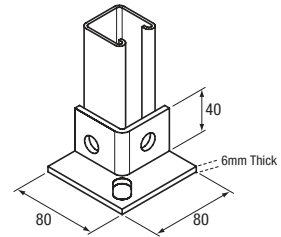
Base plate (single channel)

Model	Hole Size
KBP380-6	80x80x6
KBP380-8	80x80x8
KBP380-10	80x80x10
KBP380-12	80x80x12

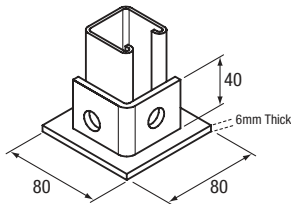
Base plate (single channel)

Model	Hole Size
KBP280-6	80x80x6
KBP280-8	80x80x8
KBP280-10	80x80x10
KBP280-12	80x80x12

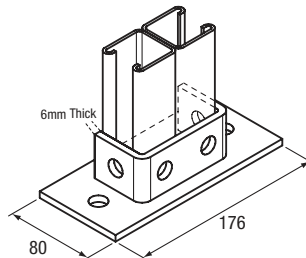
Base plate (double channel)

Model	Hole Size
KRBP-6	176x80x6
KRBP-8	176x80x8
KRBP-10	176x80x10
KRBP-12	176x80x12

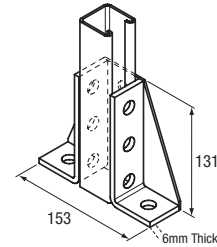
Wing fitting with gussets

Model	Hole Size
KWGP-6	131x153x6
KWGP-8	131x153x8
KWGP-10	131x153x10
KWGP-12	131x153x12

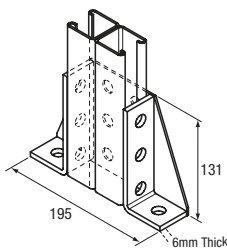
Wing fitting for double channel

Model	Hole Size
K24B-6	131x95x6
K24B-8	131x95x8
K24B-10	131x95x10
K24B-12	131x95x12

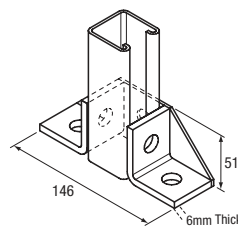
Short wing fitting with gussets

Model	Hole Size
KSWB-6	51x146x6
KSWB-8	51x146x8
KSWB-10	51x146x10
KSWB-12	51x146x12

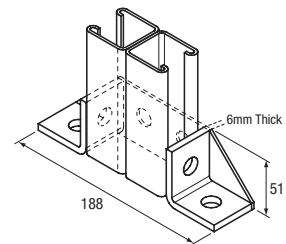
Short wing fitting for double channel

Model	Hole Size
K25B-6	51x188x6
K25B-8	51x188x8
K25B-10	51x188x10
K25B-12	51x188x12

Dimension in Millimeter

Finish

HDG- Hot Dip Galvanized

PG - Pre Galvanized

Al - Aluminum Alloy - SS34 (SS304 Grade), SS36 (SS316 Grade)

EP - Epoxy Coated, PC - PVC Coated, GP-GRP/FRP Products

When ordering please Indicate Material and Finish.

All measurement are in millimeter (mm) unless otherwise specified

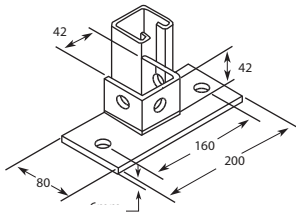
Post Base

Model	Hole Size
KR5B-6	6m
KR5B-8	8m
KR5B-10	10m
KR5B-12	12m

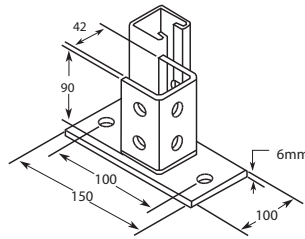
Post Base

Model	Hole Size
KRB6-6	6m
KRB6-8	8m
KRB6-10	10m
KRB6-12	12m

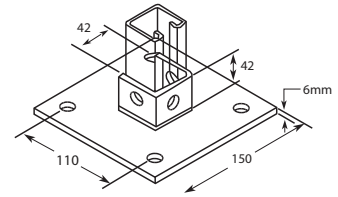
Post Base

Model	Hole Size
KPB6-6	6m
KPB6-8	8m
KPB6-10	10m
KPB6-12	12m

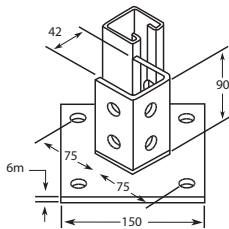

Model	Hole Size
KPB2-6	6m
KPB2-8	8m
KPB2-10	10m
KPB2-12	12m

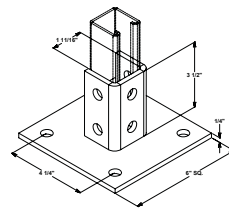

Model	Hole Size
KP5-6	6m
KP5-8	8m
KP5-10	10m
KP5-12	12m

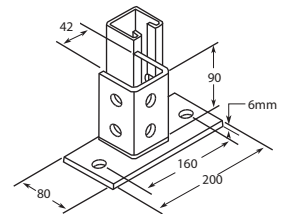

Model	Hole Size
KR8B-6	6m
KPB5-8	8m
KPB5-10	10m
KPB5-12	12m

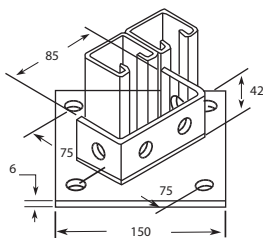

Model	Hole Size
KPB3-6	6m
KPB3-8	8m
KPB3-10	10m
KPB3-12	12m

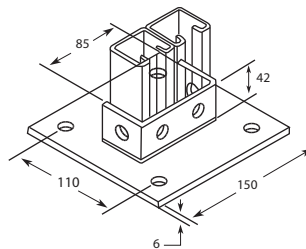

Model	Hole Size
KP3-6	6m
KP3-8	8m
KP3-10	10m
KP3-12	12m

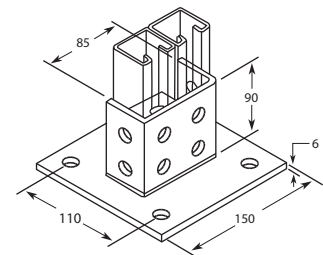

Model	Hole Size
KPB7-6	6m
KPB7-8	8m
KPB7-10	10m
KPB7-12	12m

Dimension in Millimeter

Finish

HDG-Hot Dip Galvanized

PG - Pre Galvanized

Al - Aluminum Alloy - SS34 (SS304 Grade), SS36 (SS316 Grade)

EP - Epoxy Coated, PC - PVC Coated, GP-GRP/FRP Products

When ordering please Indicate Material and Finish.

All measurement are in millimeter (mm) unless otherwise specified

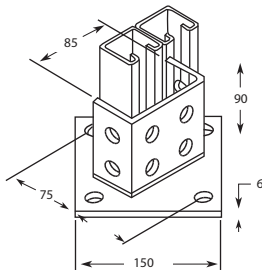
Post Base

Model	Hole Size
KPB8-6	6m
KPB8-8	8m
KPB8-10	10m
KPB8-12	12m

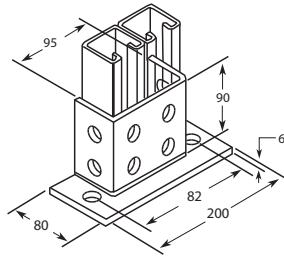
Post Base

Model	Hole Size
KRB10-6	6m
KRB10-8	8m
KRB10-10	10m
KRB11-12	12m

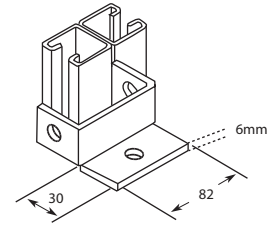
Post Base

Model	Hole Size
K3PB-6	6m
K3PB-8	8m
K3PB-10	10m
K3PB-12	12m

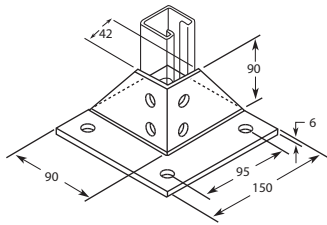
Base Base

Model	Hole Size
KPB9-6	6m
KPB9-8	8m
KPB9-10	10m
KPB9-12	12m

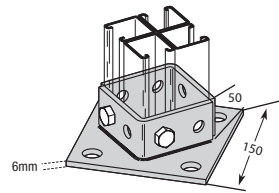
Base Base

Model	Hole Size
K14PB-6	6m
K14PB-8	8m
K14PB-10	10m
K14PB-12	12m

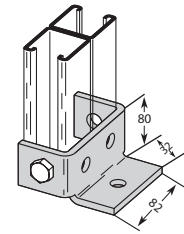
Double Base Plate (3H)

Model	Hole Size
KC3B-6	6m
KC3B-8	8m
KC3B-10	10m
KC3B-12	12m

Dimension in Millimeter

Finish

HDG-Hot Dip Galvanized

PG - Pre Galvanized

Al - Aluminum Alloy - SS34 (SS304 Grade), SS36 (SS316 Grade)

EP - Epoxy Coated, PC - PVC Coated, GP-GRP/FRP Products

When ordering please Indicate Material and Finish.

All measurement are in millimeter (mm) unless otherwise specified

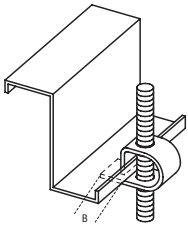
'Z' Purlin Clip

Model	B (mm) / Hole
KZPC-6	MAX-6
KZPC-8	MAX-8
KZPC-10	MAX-10
KZPC-12	MAX-12

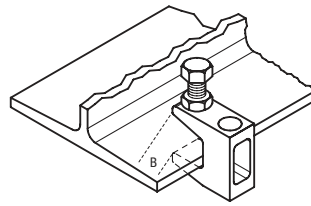
Beam Clamp

Model	B (mm) / Hole
KBC18-6	MAX18mm-6
KBC18-8	MAX18mm-8
KBC18-10	MAX18mm-10
KBC20-12	MAX20mm-8
KBC20-12	MAX20mm-10
KBC20-12	MAX20mm-12

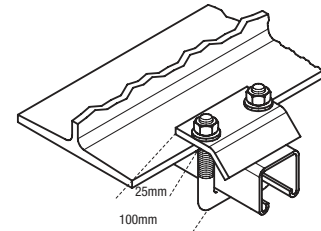
Beam Clamp (Deep Channel)

Model	B (mm) / Hole
KDBC-8	100x25x25x8
KDBC8-10	100x25x25x10
KDBC-12	100x25x25x12

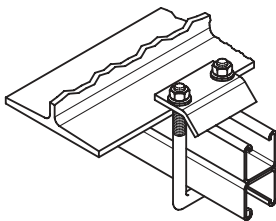
Beam Clamp (back to back deep channel)

Model	B (mm) / Hole
K2BC-8	125x25x25x8
K2BC-10	125x25x25x12
K2BC-12	125x25x25x12

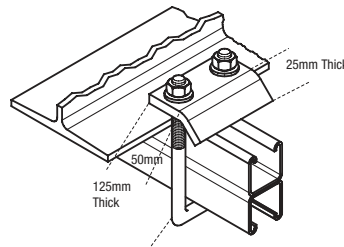
Beam Clamp Heavy Duty

Model	B (mm) / Hole
K2BH-8	125x50x25x8
K2BH-10	125x50x25x12
K2BH-12	125x50x25x12

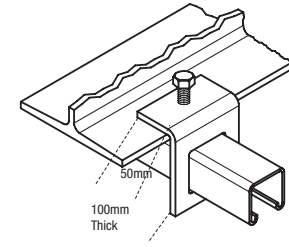
Beam Clamp (deep channel)

Model	B (mm) / Hole
KWBC-8	100x50x8
KWBC-10	100x50x10
KWBC-12	100x50x12

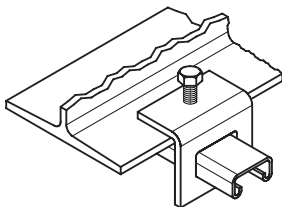
Beam Clamp (Window)

Model	B (mm) / Hole
KWBC-8	70x50x8
KWBC-10	70x50x10
KWBC-12	70x50x12

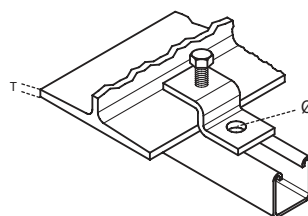
Beam Bracket

Model	T (Thick) mm	Ø mm
K2BC-16-6	16	6
K2BC-16-8	16	8
K2BC-16-10	16	10
K2BC-16-12	16	12

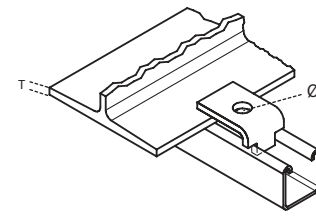
Beam Clamp

Model	T (Thick) mm	Ø mm
KSBC-16-6	16	6
KSBC-16-8	16	8
KSBC-16-10	16	10
KSBC-16-12	16	12

Dimension in Millimeter

Finish

HDG- Hot Dip Galvanized

PG - Pre Galvanized

Al - Aluminum Alloy - SS34 (SS304 Grade), SS36 (SS316 Grade)

EP - Epoxy Coated, PC - PVC Coated, GP-GRP/FRP Products

When ordering please Indicate Material and Finish.

All measurement are in millimeter (mm) unless otherwise specified

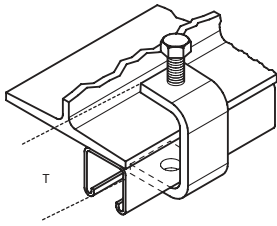

Beam clamp

Model	T (Thick) mm	Ø mm
KLSN-16-6	5	6
KLSN-16-8	6	8
KLSN-16-10	8	10
KLSN16-12	8	12

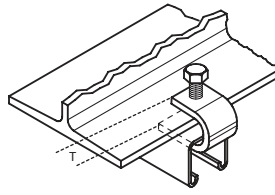

Beam clamp

Model	T (Thick) mm	Ø mm
KSCN-6	5	6
KSCN-8	6	8
KSCN-10	8	10
KSCN-12	8	12

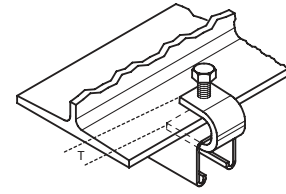

Beam clamp

Model	T (Thick) mm	Ø mm
KBC16-6	5	6
KBC16-8	6	8
KBC16-10	8	10
KBC16-12	8	12

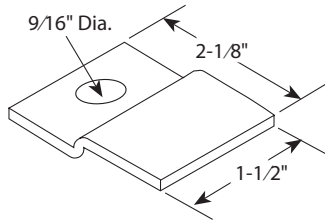

Expansion Guide Clamp

Model	Hole Size
KSEG-6	6m
KSEG-8	8m
KSEG-10	10m
KSEG-12	12m

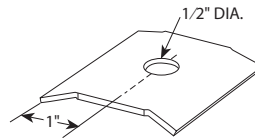

Hold Down Clamp

Model	Hole Size
KSHC-6	6m
KSHC-8	8m
KSHC-10	10m
KSHC-12	12m

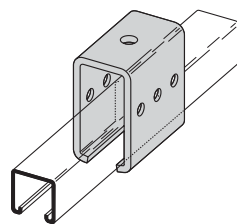
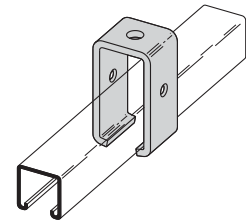

Beam Support HD

Model	Hole Size
KHBS-6	6m
KHBS-8	8m
KHBS-10	10m
KHBS-12	12m

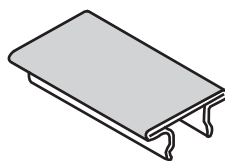

Closure Strip - PVC

Model No.	W(Kg)
KSP3	3 Mtr

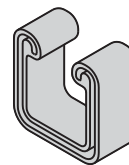

Profile End Caps

Model	Size
KSEL41	41x41
KWBC-10	21x21
KWBC-12	41x21

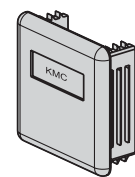

End Caps - PVC

Model	Size
KSEL41	41x41
KSELP-10	21x21
KSELP-12	41x21

Dimension in Millimeter

Finish

HDG-Hot Dip Galvanized

PG - Pre Galvanized

Al - Aluminum Alloy - SS34 (SS304 Grade), SS36 (SS316 Grade)

EP - Epoxy Coated, PC - PVC Coated, GP-GRP/FRP Products

When ordering please Indicate Material and Finish.

All measurement are in millimeter (mm) unless otherwise specified

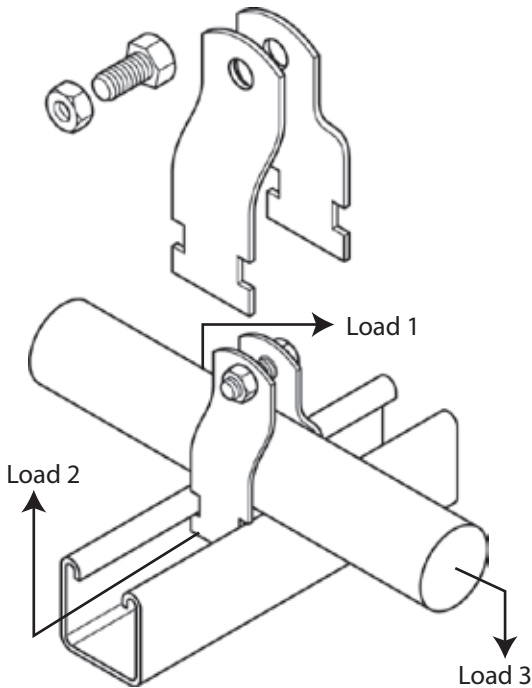
Pipe Clamp

Model No.	Size (Inch)	OD Size	Thickness	Load1	Load2	Load3	Finish
KSPC025	1/4"	6.3mm	1.5mm	0.54 kN	0.13 kN	0.13 kN	Zinc Plated / Hot Dipped Galvanized & Stainless steel Can be used for rigid, EMT Conduits and Copper pipes
KSPC050	1/2"	12.7mm	1.5mm	1.78 kN	0.22kN	0.22kN	
KSPC075	3/4"	19.0mm	1.5mm	1.78 kN	0.22kN	0.22kN	
KSPC100	1"	25.4mm	1.9mm	2.22 kN	0.33kN	0.33kN	
KSPC125	1 1/4"	31.7mm	1.9mm	2.67 kN	0.33kN	0.33kN	
KSPC150	1 1/2"	38.1mm	1.9mm	2.67 kN	0.33kN	0.33kN	
KSPC200	2"	50.8mm	2.6mm	3.56 kN	0.56kN	0.56kN	
KSPC250	2 1/2"	63.5mm	2.6mm	3.56 kN	0.56kN	0.56kN	
KSPC300	3"	76.2mm	2.6mm	3.56 kN	0.56kN	0.56kN	
KSPC350	3 1/2"	88.9mm	2.6mm	3.56 kN	0.56kN	0.56kN	
KSPC400	4"	101.6mm	3.0mm	4.45 kN	0.89kN	0.67kN	
KSPC450	4 1/2"	114.3mm	3.0mm	4.45 kN	0.89kN	0.67kN	
KSPC500	5"	127.0mm	3.0mm	4.45 kN	0.89kN	0.67kN	
KSPC550	5 1/2"	139.7mm	3.0mm	4.45 kN	0.89kN	0.67kN	
KSPC600	6"	152.4mm	3.0mm	4.45 kN	0.89kN	0.67kN	
KSPC650	6 1/2"	165.1mm	3.0mm	4.45 kN	1.11kN	0.89kN	
KSPC700	7"	177.8mm	3.0mm	4.45 kN	1.11kN	0.89kN	
KSPC800	8"	203.2mm	3.0mm	4.45 kN	1.11kN	0.89kN	

PG: Pregalvanized Steel as per BS EN 10326 (2004)
 HDG: Hot dipped Galvanized Steel as per BS EN ISO 1461(1999)
 SS: Stainless Steel to BS EN 10088 - 2(2005)
 Note : More technical details available upon request

Dimension in Millimeter

Finish
 HDG-Hot Dip Galvanized
 PG - Pre Galvanized
 Al - Aluminum Alloy - SS34 (SS304 Grade), SS36 (SS316 Grade)
 EP - Epoxy Coated, PC - PVC Coated, GP-GRP/FRP Products
 When ordering please Indicate Material and Finish.
 All measurement are in millimeter (mm) unless otherwise specified

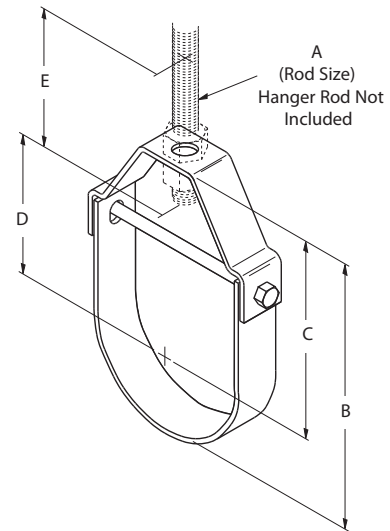

Part No.	Pipe Size		Rod Size	B		C		D	
	In	(mm)	A	In	(mm)	In	(mm)	In	(mm)
KSCHH1050	1/2"	(15)	3/8"-16	2-1/8"	(54.0)	1-11/16"	(42.9)	15/16"	(23.8)
KSCHH1075	3/4"	(20)	3/8"-16	2-7/16"	(61.9)	1-7/8"	(47.6)	1-1/8"	(28.6)
KSCHH10100	1"	(25)	3/8"-16	2-13/16"	(71.4)	2-1/8"	(54.0)	1-3/8"	(34.9)
KSCHH10125	1-1/4"	(32)	3/8"-16	3-7/16"	(87.3)	2-9/16"	(65.1)	1-13/16"	(46.0)
KSCHH10150	1-1/2"	(40)	3/8"-16	4"	(101.6)	3"	(76.2)	2-1/4"	(57.1)
KSCHH10200	2"	(50)	3/8"-16	4-1/2"	(114.3)	4"	(101.6)	2-1/2"	(63.5)
KSCHH10250	2-1/2"	(65)	1/2"-13	5-9/16"	(141.3)	4"	(101.6)	3-1/16"	(77.8)
KSCHH10300	3"	(80)	1/2"-13	6-3/4"	(171.4)	4-7/8"	(123.8)	3-15/16"	(100.0)
KSCHH10350	3-1/2"	(90)	1/2"-13	7"	(177.8)	5"	(127.0)	4-1/16"	(103.2)
KSCHH10400	4"	(100)	5/8"-11	7-13/16"	(198.4)	5-1/2"	(139.7)	4-3/8"	(111.1)
KSCHH10500	5"	(125)	5/8"-11	9-1/16"	(230.2)	6-1/8"	(155.6)	5"	(127.0)
KSCHH10600	6"	(150)	3/4"-10	10-7/16"	(265.1)	6-15/16"	(176.2)	5-11/16"	(144.5)
KSCHH10800	8"	(200)	3/4"-10	12-3/4"	(323.8)	8-3/8"	(212.7)	7-1/8"	(181.0)

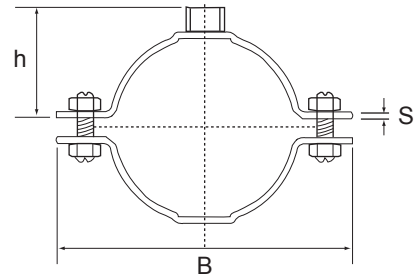
Pipe Clamp

Model No.	Size	Clamping Range	Connection	B(mm)	bxs(mm)	h(mm)	Packing (pcs)
KSPG025	1/4"	10-15mm	M8	49	24 x 2.5	25	50
KSPG050	1/2"	20-25mm	M8	61	24 x 2.5	39	50
KSPG075	3/4"	25-30mm	M8	67	24 x 2.5	42	50
KSPG100	1"	32-38mm	M8	75	24 x 2.5	45	50
KSPG125	1 1/4"	40-45mm	M8	83	24 x 2.5	49	25
KSPG150	1 1/2"	48-54mm	M8/M10	92	24 x 2.5	53	25
KSPG200	2"	57-64mm	M8/M10	104	24 x 2.5	58	25
KSPG250	2 1/2"	70-77mm	M8/M10	122	24 x 2.5	58	25
KSPG300	3"	82-90mm	M8/M10	135	24 x 2.5	65	20
KSPG400	4"	108-114mm	M8/M10	165	30 x 2.5	77	20
KSPG500	5"	137-142mm	M10/M12	193	30 x 2.5	91	10
KSPG600	6"	162-168mm	M10/M12	223	30 x 2.5	105	10
KSPG650	6 1/2"	190-200mm	M12/M16	254	30 x 3	122	10
KSPG800	8"	217-224mm	M12/M16	279	30 x 3	135	5

PG: Pregalvanized Steel as per BS EN 10326 (2004)
 HDG: Hot dipped Galvanized Steel as per BS EN ISO 1461(1999)
 SS: Stainless Steel to BS EN 10088 - 2(2005)
 Note : More technical details available upon request

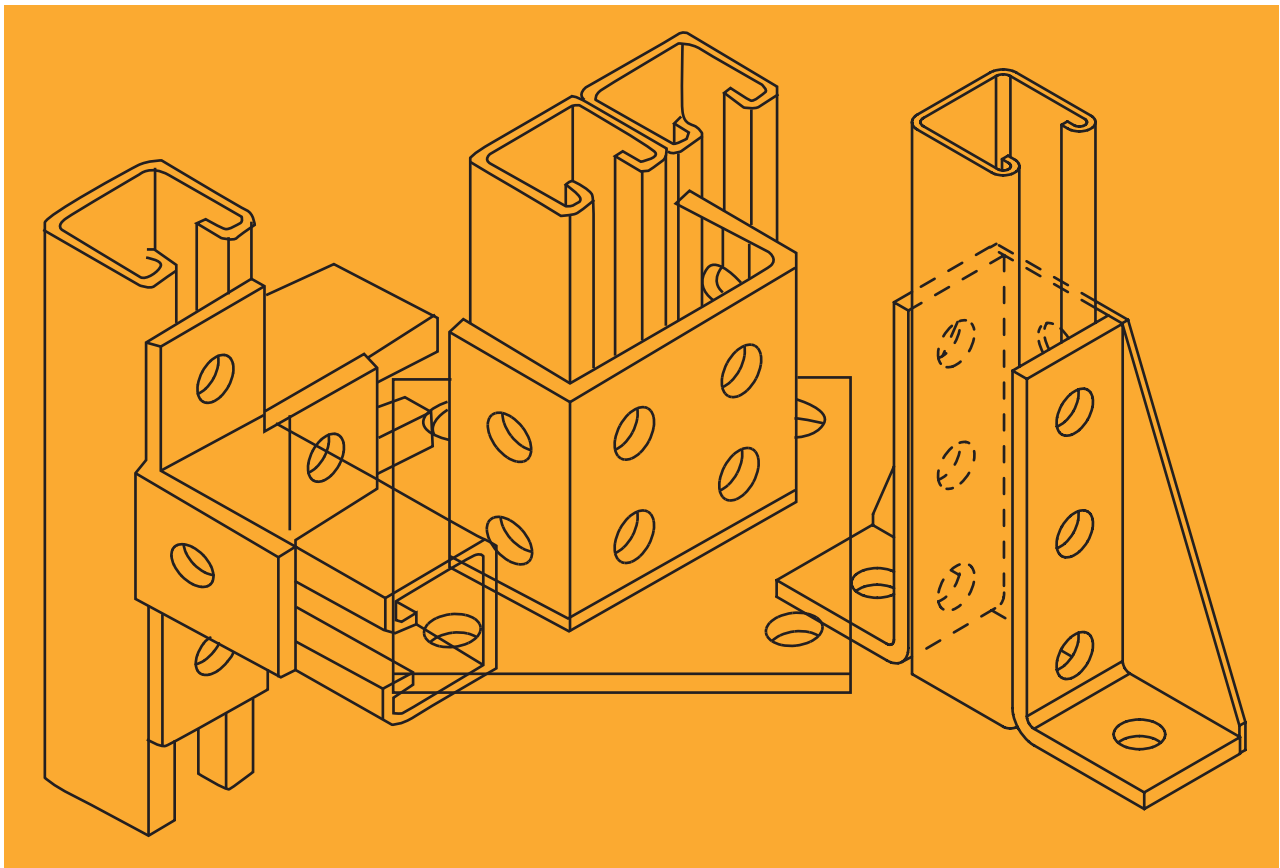
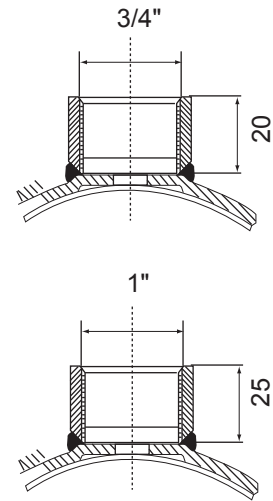

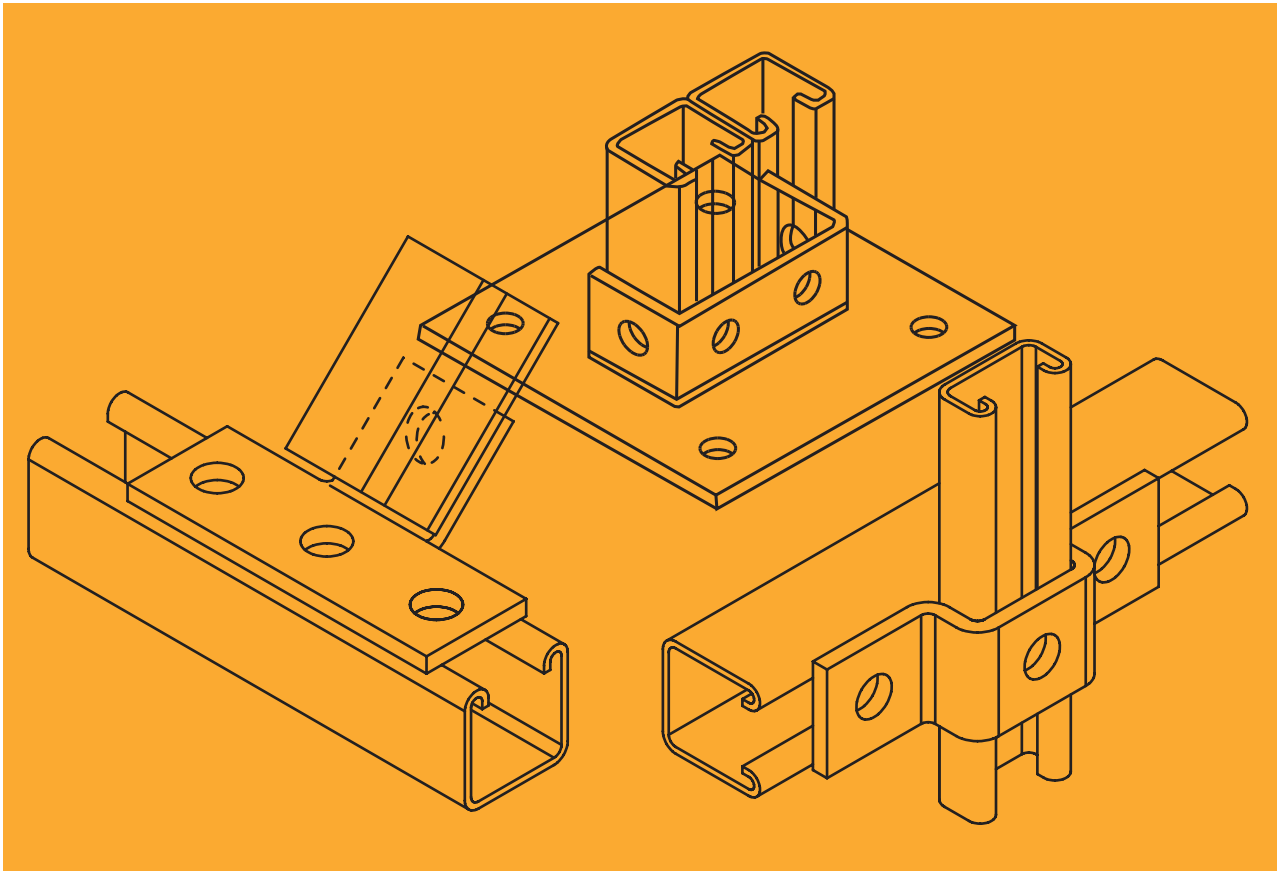

Pipe Clamp with Rubber Lining

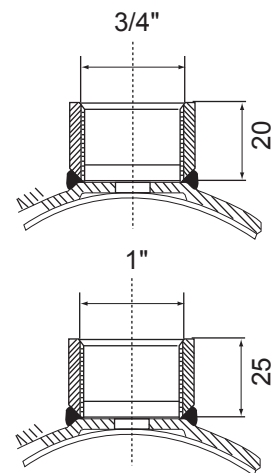
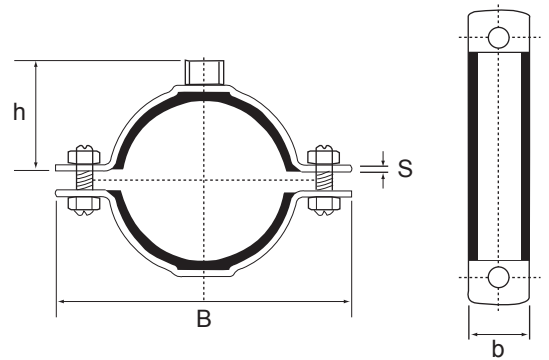

Model No.	Size	Clamping Range	Connection	B(mm)	bxs(mm)	h(mm)	Packing (pcs)
KSPR025	1/4"	12-15mm	M8	54	20 x 1.5	18	50
KSPR050	1/2"	20-23mm	M8	62	20 x 1.5	22	50
KSPR075	3/4"	25-28mm	M8	68	20 x 1.5	24	50
KSPR100	1"	32-35mm	M8	76	20 x 1.5	28	50
KSPR125	1 1/4"	40-45mm	M8	92	20 x 1.5	32	25
KSPR150	1 1/2"	48-52mm	M8/M10	99	20 x 1.5	34	25
KSPR200	2"	60-64mm	M8/M10	112	20 x 1.5	42	25
KSPR250	2 1/2"	75-80mm	M8/M10	134	20 x 1.5	52	25
KSPR300	3"	86-91mm	M8/M10	146	20 x 1.5	58	20
KSPR400	4"	110-115mm	M8/M10	173	20 x 1.5	70	20
KSPR500	5"	138-144mm	M10/M12	197	25 x 2.5	84	10
KSPR600	6"	164-170mm	M10/M12	223	25 x 2.5	97	10
KSPR650	6 1/2"	190-200mm	M12/M16	229	30 x 3	127	10
KSPR800	8"	242-250mm	M12/M16	314	30 x 3	152	5

Material : Steel as per BSEN 10111
 Rubber : EPDM, Hardness 50 \pm 5°
 Note : More technical details available upon request

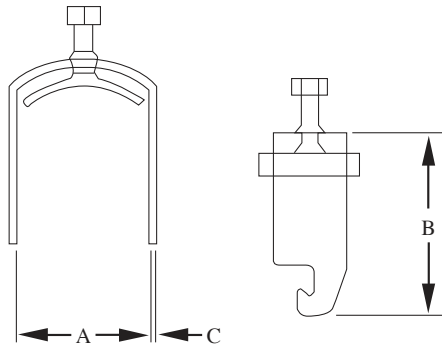
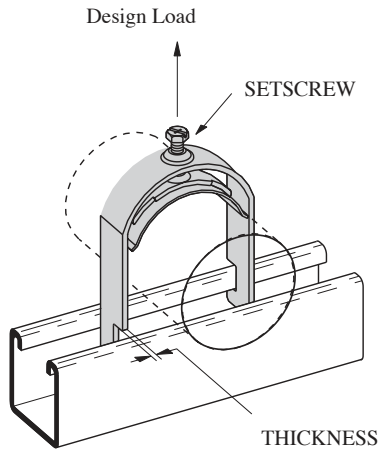

Cable clamp single

Part No.	Size	A	B	C	Packaging (Pcs)
KSCC06	6-12mm	12mm	40mm	1.9mm	100
KSCC012	12-14mm	14mm	42mm	1.9mm	100
KSCC014	14-16mm	16mm	45mm	1.9mm	100
KSCC016	16-18mm	18mm	51mm	1.9mm	100
KSCC018	18-22mm	22mm	51mm	1.9mm	100
KSCC022	22-26mm	26mm	51mm	1.9mm	50
KSCC026	26-30mm	30mm	57mm	1.9mm	50
KSCC030	30-34mm	34mm	63mm	2.7mm	50
KSCC034	34-38mm	38mm	63mm	2.7mm	25
KSCC038	38-42mm	42mm	70mm	2.7mm	25
KSCC042	42-46mm	46mm	70mm	2.7mm	25
KSCC046	46-50mm	50mm	76mm	2.7mm	25
KSCC050	50-54mm	54mm	82mm	2.7mm	25
KSCC054	54-58mm	58mm	82mm	3.4mm	1
KSCC058	58-64mm	64mm	92mm	2.7mm	25
KSCC064	64-70mm	70mm	92mm	2.7mm	25
KSCC070	70-76mm	76mm	101mm	2.7mm	25
KSCC076	76-82mm	82mm	101mm	2.7mm	25
KSCC082	82-90mm	90mm	114mm	3.4mm	25
KSCC090	90-96mm	96mm	127mm	3.4mm	25
KSCC096	96-105mm	105mm	142mm	3.4mm	1

Material : Steel as per BSEN 10111, Hot Dip Galvanized as BS EN ISO 1461 (BS729)
 Material : For SS304 - Please add SS34 after the Part No.
 Material : For SS316 - Please add SS36 after the Part No.
 Note : More technical details available upon request

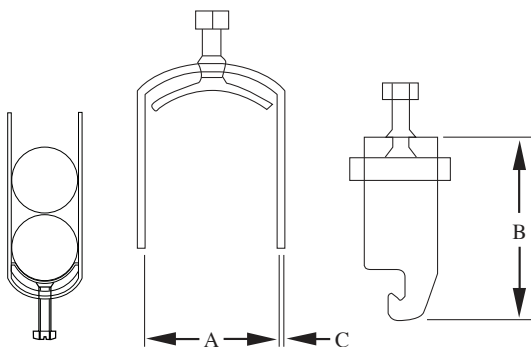
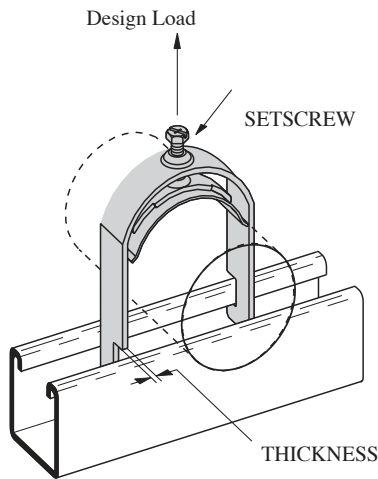

Cable clamp double

Part No.	Size	A	B	C	Packaging (Pcs)
KSCC206	6-12mm	12mm	80mm	1.9mm	100
KSCC2012	12-14mm	14mm	84mm	1.9mm	100
KSCC2014	14-16mm	16mm	90mm	1.9mm	100
KSCC2016	16-18mm	18mm	102mm	1.9mm	100
KSCC2018	18-22mm	22mm	102mm	1.9mm	100
KSCC2022	22-26mm	26mm	102mm	1.9mm	50
KSCC2026	26-30mm	30mm	114mm	1.9mm	50
KSCC2030	30-34mm	34mm	126mm	2.7mm	50
KSCC2034	34-38mm	38mm	126mm	2.7mm	25
KSCC2038	38-42mm	42mm	140mm	2.7mm	25
KSCC2042	42-46mm	46mm	140mm	2.7mm	25
KSCC2046	46-50mm	50mm	152mm	2.7mm	25
KSCC2050	50-54mm	54mm	164mm	2.7mm	25
KSCC2054	54-58mm	58mm	164mm	3.4mm	1
KSCC2058	58-64mm	64mm	184mm	2.7mm	25
KSCC2064	64-70mm	70mm	184mm	2.7mm	25
KSCC2070	70-76mm	76mm	202mm	2.7mm	25
KSCC2076	76-82mm	82mm	202mm	2.7mm	25
KSCC2082	82-90mm	90mm	228mm	3.4mm	25
KSCC2090	90-96mm	96mm	254mm	3.4mm	25
KSCC2096	96-105mm	105mm	284mm	3.4mm	1

Material : Steel as per BSEN 10111, Hot Dip Galvanized as BS EN ISO 1461 (BS729)
 Material : For SS304 - Please add SS34 after the Part No.
 Material : For SS316 - Please add SS36 after the Part No.
 Note : More technical details available upon request

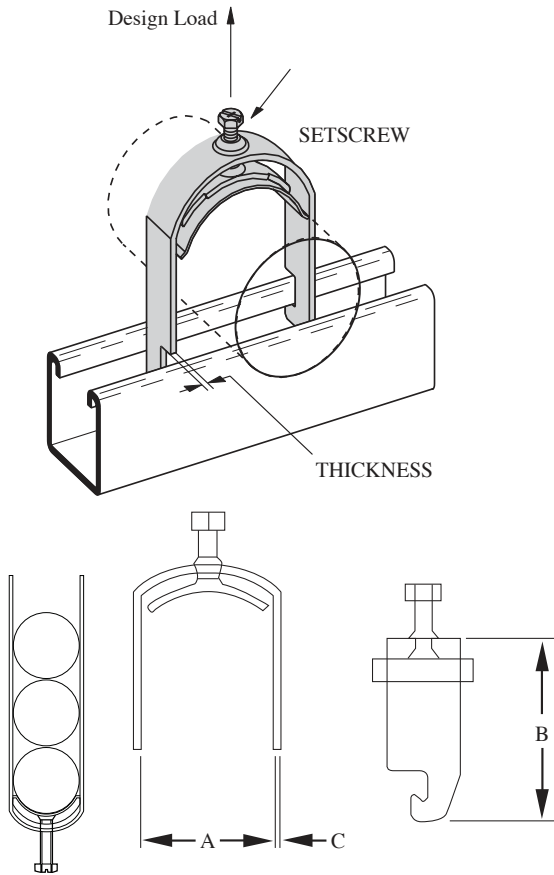

Cable clamp threepole

Part No.	Size	A	B	C	Packaging (Pcs)
KSCC306	6-12mm	12mm	120mm	1.9mm	100
KSCC3012	12-14mm	14mm	126mm	1.9mm	100
KSCC3014	14-16mm	16mm	135mm	1.9mm	100
KSCC3016	16-18mm	18mm	153mm	1.9mm	100
KSCC3018	18-22mm	22mm	153mm	1.9mm	100
KSCC3022	22-26mm	26mm	153mm	1.9mm	50
KSCC3026	26-30mm	30mm	171mm	1.9mm	50
KSCC3030	30-34mm	34mm	189mm	2.7mm	50
KSCC3034	34-38mm	38mm	189mm	2.7mm	25
KSCC3038	38-42mm	42mm	210mm	2.7mm	25
KSCC3042	42-46mm	46mm	210mm	2.7mm	25
KSCC3046	46-50mm	50mm	228mm	2.7mm	25
KSCC3050	50-54mm	54mm	246mm	2.7mm	25
KSCC3054	54-58mm	58mm	246mm	3.4mm	1
KSCC3058	58-64mm	64mm	276mm	2.7mm	25
KSCC3064	64-70mm	70mm	276mm	2.7mm	25
KSCC3070	70-76mm	76mm	303mm	2.7mm	25
KSCC3076	76-82mm	82mm	303mm	2.7mm	25
KSCC3082	82-90mm	90mm	342mm	3.4mm	25
KSCC3090	90-96mm	96mm	381mm	3.4mm	25
KSCC3096	96-105mm	105mm	426mm	3.4mm	1

Material : Steel as per BSEN 10111, Hot Dip Galvanized as BS EN ISO 1461 (BS729)

Material : For SS304 - Please add SS34 after the Part No.

Material : For SS316 - Please add SS36 after the Part No.

Note : More technical details available upon request

Cable clamp wide beam

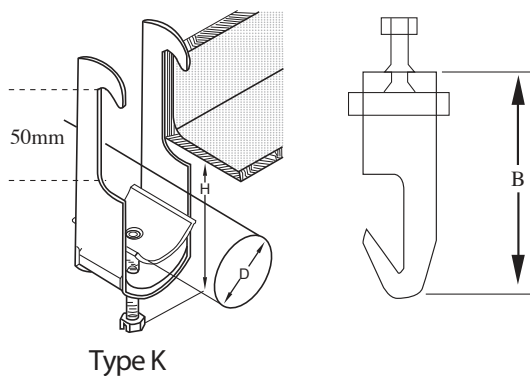

Part No.	Size	A	B	C	Packaging (Pcs)
KSCK06	6-12mm	12mm	40mm	1.9mm	100
KSCK012	12-14mm	14mm	42mm	1.9mm	100
KSCK014	14-16mm	16mm	45mm	1.9mm	100
KSCK016	16-18mm	18mm	51mm	1.9mm	100
KSCK018	18-22mm	22mm	51mm	1.9mm	100
KSCK022	22-26mm	26mm	51mm	1.9mm	50
KSCK026	26-30mm	30mm	57mm	1.9mm	50
KSCK030	30-34mm	34mm	63mm	2.7mm	50
KSCK034	34-38mm	38mm	63mm	2.7mm	25
KSCK038	38-42mm	42mm	70mm	2.7mm	25
KSCK042	42-46mm	46mm	70mm	2.7mm	25
KSCK046	46-50mm	50mm	76mm	2.7mm	25
KSCK050	50-54mm	54mm	82mm	2.7mm	25
KSCK054	54-58mm	58mm	82mm	3.4mm	1
KSCK058	58-64mm	64mm	92mm	2.7mm	25
KSCK064	64-70mm	70mm	92mm	2.7mm	25
KSCK070	70-76mm	76mm	101mm	2.7mm	25
KSCK076	76-82mm	82mm	101mm	2.7mm	25
KSCK082	82-90mm	90mm	114mm	3.4mm	25
KSCK090	90-96mm	96mm	127mm	3.4mm	25
KSCK096	96-105mm	105mm	142mm	3.4mm	1

Material : Steel as per BSEN 10111, Hot Dip Galvanized as BS EN ISO 1461 (BS729)

Material : For SS304 - Please add SS34 after the Part No.

Material : For SS316 - Please add SS36 after the Part No.

Note : More technical details available upon request

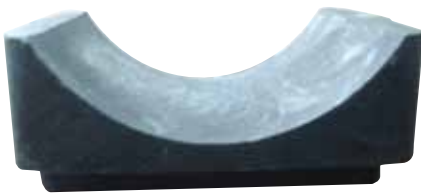
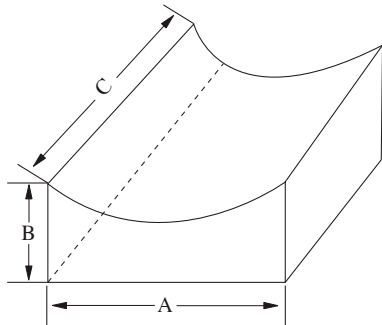
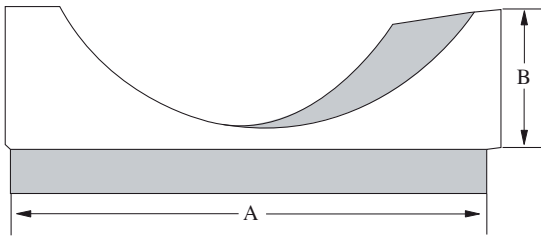

Cable Clamp Base Plate

Part No.	Size	A	B	C	Packaging (Pcs)
KSCBP06	6-12mm	12mm	120mm	1.9mm	100
KSCBP012	12-14mm	14mm	126mm	1.9mm	100
KSCBP014	14-16mm	16mm	135mm	1.9mm	100
KSCBP016	16-18mm	18mm	153mm	1.9mm	100
KSCBP018	18-22mm	22mm	153mm	1.9mm	100
KSCBP022	22-26mm	26mm	153mm	1.9mm	50
KSCBP026	26-30mm	30mm	171mm	1.9mm	50
KSCBP030	30-34mm	34mm	189mm	2.7mm	50
KSCBP034	34-38mm	38mm	189mm	2.7mm	25
KSCBP038	38-42mm	42mm	210mm	2.7mm	25
KSCBP042	42-46mm	46mm	210mm	2.7mm	25
KSCBP046	46-50mm	50mm	228mm	2.7mm	25
KSCBP050	50-54mm	54mm	246mm	2.7mm	25
KSCBP054	54-58mm	58mm	246mm	3.4mm	1
KSCBP058	58-64mm	64mm	276mm	2.7mm	25
KSCBP064	64-70mm	70mm	276mm	2.7mm	25
KSCBP070	70-76mm	76mm	303mm	2.7mm	25
KSCBP076	76-82mm	82mm	303mm	2.7mm	25
KSCBP082	82-90mm	90mm	342mm	3.4mm	25
KSCBP090	90-96mm	96mm	381mm	3.4mm	25
KSCBP096	96-105mm	105mm	426mm	3.4mm	1

Material : Material : Glass fibre reinforced Polyamide, fire resistant, high UV and Chemical resistance and operating Temperature
 Temperature : -40°C - +135°C
 Note : More technical details available upon request

Pipe Clamp Hanger

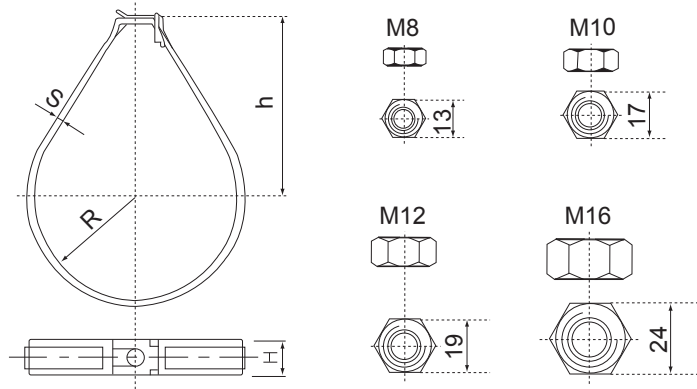

Model No.	Size (Inch)	Clamping Range	Connection	R(mm)	bxs(mm)	h(mm)	Packing (pcs)
KSPH050	1/2"	19-24mm	M8	13	21 x 1.5	40	50
KSPH075	3/4"	27-28mm	M8	15	21 x 1.5	50	50
KSPH100	1"	34-35mm	M8	18	21 x 1.5	50	50
KSPH125	1 1/4"	42-45mm	M8	23	21 x 1.5	58	50
KSPH150	1 1/2"	48-51mm	M8/M10	26	21 x 1.5	65	50
KSPH200	2"	57-64mm	M8/M10	33	21 x 1.5	73	50
KSPH250	2 1/2"	70-76mm	M10/M12	39	20 x 2.5	78	25
KSPH300	3"	83-89mm	M10/M12	46	20 x 2.5	96	25
KSPH400	4"	108-114mm	M10/M12	58	20 x 2.5	131	25
KSPH500	5"	140-148mm	M12/M16	71	24 x 2.5	115	25
KSPH600	6"	165-168mm	M12/M16	81	24 x 2.5	133	25
KSPH800	8"	212-219mm	M12/M16	111	36 x 2.5	186	10

PG: Pregalvanized Steel as per BS EN 10326 (2004)
 HDG: Hot Dipped Galvanized Steel as per BS EN ISO 1461(1999)
 SS: Stainless Steel to BS EN 10088 - 2(2005)
 Note : More technical details available upon request

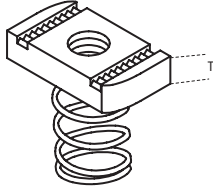
Channel Nut - Long Spring

Model	T (mm) x Hole
KSNL6	5x6
KSNL8	6x8
KSNL10	6x10
KSNL12	7x12

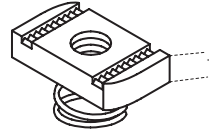
Channel Nut - Short Spring

Model	T (mm) x Hole
KSNS6	5x6
KSNS8	6x8
KSNS10	6x10
KSNS12	7x12

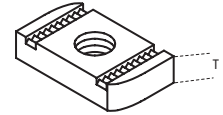
Channel Nut - No Spring

Model	T (mm) x Hole
KSN6	5x6
KSN8	6x8
KSN10	6x10
KSN12	7x12

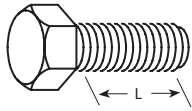
Hex Head Setscrew

Model No.	Length	Thread(mm)
KHB6-20	20	6
KHB8-20	30	8
KHB10-40	40	10
KHB12-50	50	12

Hexagon Nut

Model	Size
KHN-6	6
KHN-8	8
KHN-10	10
KHN-12	12

Flat Washers

Model	T (mm) x Hole
KFW-6	6
KFW-8	8
KFW-10	10
KFW-12	12

Flat Washers

Model	Size
KSW-6	6
KSW-8	8
KSW-10	10
KSW-12	12

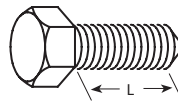
Cone Point Setscrew

Model No.	Length	Thread(mm)
KHPS-20	20	6
KHPS-30	30	8
KHPS-40	40	10
KHPS-50	50	12

Mushroom Head Bolt & Nut

Model	Size
KMHS-6	6x15
KMHS-8	8x18
KMHS-10	10x20
KMHS-12	12x25

Mushroom Head Bolt

Model	Size
KMHB-6	6x15
KMHB-8	8x18
KMHB-10	10x20
KMHB-12	12x25

Mushroom Nut

Model	Size
KMN-6	6
KMN-8	8
KMN-10	10
KMN-12	12

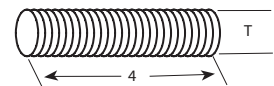
Studding & Studding Connectors

Model No.	Length	Thread(mm)
KSTR-6	2000	6
KSTR-8	2000	8
KSTR-10	2000	10
KSTR-12	2000	12

Kruppsmetal Corporation Consists of these Products



KRUPPSSTRUT



KRUPPSFIBER



KRUPPSTRAY



KRUPPSTRUNKING



KRUPPSFLEX



KRUPPSENCLOSURE



KRUPPSLADDER



KRUPPSCONDUIT

Middle East Marketing Office:

Delta Group

Tel : +973 17280009 / 17280200

Fax : +973 17280449

Manama, Kingdom of Bahrain

E-mail: sales@deltaelectricals.com

Web: www.deltaelectricals.com

KRUPPSMETAL Corporation.

Barnet Street, Yarravilla, Victoria 3013
Australia.

Email: sales@kruppsmetal.net
www.kruppsmetal.net